

# GeoMax Zoom80 Series User Manual

---



Version 2.2

# Introduction

## Purchase

Congratulations on the purchase of a Zoom80 series instrument.



This manual contains important safety directions as well as instructions for setting up the product and operating it. Refer to "6 Safety Directions" for further information. Read carefully through the User Manual before you switch on the product.

## Product identification

The type and serial number of your product are indicated on the type plate. Enter the type and serial number in your manual and always refer to this information when you need to contact your agency or GeoMax authorised service workshop.

Type: \_\_\_\_\_

Serial No.: \_\_\_\_\_

## Symbols

The symbols used in this manual have the following meanings:

Type	Description
<b>DANGER</b>	Indicates an imminently hazardous situation which, if not avoided, will result in death or serious injury.
<b>WARNING</b>	Indicates a potentially hazardous situation or an unintended use which, if not avoided, could result in death or serious injury.
<b>CAUTION</b>	Indicates a potentially hazardous situation or an unintended use which, if not avoided, may result in minor or moderate injury.
<b>NOTICE</b>	Indicates a potentially hazardous situation or an unintended use which, if not avoided, may result in appreciable material, financial and environmental damage.
	Important paragraphs which must be adhered to in practice as they enable the product to be used in a technically correct and efficient manner.

## Trademarks

- Windows is a registered trademark of Microsoft Corporation in the United States and other countries
  - CompactFlash and CF are trademarks of SanDisk Corporation
  - *Bluetooth*<sup>®</sup> is a registered trademark of Bluetooth SIG, Inc.
- All other trademarks are the property of their respective owners.

## Validity of this manual

	Description
<b>General</b>	This manual applies to all Zoom80 series instruments. Where there are differences between the models they are clearly described.
<b>Telescope</b>	<ul style="list-style-type: none"> <li>• <b>Measuring with IR mode:</b> When measuring distances to a reflector with EDM mode "IR", the telescope uses a wide visible red laser beam, which emerges coaxially from the telescope's objective.</li> <li>• <b>Measuring with RL mode and LO mode:</b> When measuring distances with EDM modes "RL" and "LO", the telescope uses a narrow visible red laser beam, which emerges coaxially from the telescope's objective.</li> </ul>

## Available documentation

Name	Description/Format		
Zoom80 Quick Guide	Provides an overview of the product together with technical data and safety directions. Intended as a quick reference guide.	✓	✓
Zoom80 User Manual	All instructions required in order to operate the product to a basic level are contained in the User Manual. Provides an overview of the product together with technical data and safety directions.	-	✓
Zoom80 Technical Reference Manual	Overall comprehensive guide to the system and program functions. Included are detailed descriptions of special software/hardware settings and software/hardware functions intended for technical specialists.	-	✓

Refer to the following resources for all Zoom80 documentation/software:

- the GeoMax Zoom80 DVD
- [www.geomax-positioning.com](http://www.geomax-positioning.com)

# Table of Contents

In this manual	Chapter	Page
<b>1</b>	<b>Description of the System</b>	<b>5</b>
1.1	System Components	5
1.2	System Concept	6
1.2.1	Software Concept	6
1.2.2	Power Concept	6
1.2.3	Data Storage and Data Conversion Concept	7
1.3	Container Contents	7
1.4	Components	8
1.4.1	Instrument	8
<b>2</b>	<b>User Interface</b>	<b>9</b>
2.1	Keyboard	9
2.1.1	Instrument	9
2.2	Screen	10
2.3	Operating Principles	10
2.3.1	Instrument	12
2.4	Icons	13
<b>3</b>	<b>Operation</b>	<b>14</b>
3.1	Instrument Setup	14
3.2	Instrument Setup for Remote Control	15
3.2.1	Remote Control Setup	15
3.2.2	LED Indicators on ZRT81	16
3.3	Autodetect Behaviour	16
3.4	Fixing the handheld to a holder and pole	17
3.5	Batteries	17
3.5.1	Operating Principles	17
3.5.2	Instrument	18
3.6	Working with the CompactFlash Card	19
3.6.1	Instrument	19
3.7	Accessing Survey Application Program	20
3.8	Guidelines for Correct Results	21
<b>4</b>	<b>Check &amp; Adjust</b>	<b>22</b>
4.1	Overview	22
4.2	Preparation	23
4.3	Combined Adjustment (l, t, i, c and Aim360)	23
4.4	Tilting Axis Adjustment (a)	25
4.5	Adjusting the Circular Level of the Instrument and Tribrach	26
4.6	Adjusting the Circular Level of the Prism Pole	26
4.7	Inspecting the Laser Plummet of the Instrument	27
4.8	Servicing the Tripod	27
<b>5</b>	<b>Care and Transport</b>	<b>28</b>
5.1	Transport	28
5.2	Storage	28
5.3	Cleaning and Drying	28
5.4	Maintenance	29
<b>6</b>	<b>Safety Directions</b>	<b>30</b>
6.1	General Introduction	30
6.2	Definition of Use	30
6.2.1	Instrument	30
6.3	Limits of Use	30
6.4	Responsibilities	31
6.5	Hazards of Use	31
6.6	Laser Classification	32
6.6.1	General	32
6.6.2	Distancer, Measurements with Reflectors	33
6.6.3	Distancer, Measurements without Reflectors	33
6.6.4	Aim360	34
6.6.5	Scout360	35
6.6.6	Navigation Light	36
6.6.7	Laser Plummet	36

6.7	Electromagnetic Compatibility EMC	37
6.8	FCC Statement, Applicable in U.S.	38
<b>7</b>	<b>Technical Data</b>	<b>40</b>
7.1	Instrument	40
7.1.1	General Technical Data of the Instrument	40
7.1.2	Angle Measurement	42
7.1.3	Distance Measurement with Reflectors	42
7.1.4	Distance Measurement without Reflectors	43
7.1.5	Distance Measurement - Long Range (LO mode)	43
7.1.6	Aim360	44
7.1.7	Scout360	45
7.1.8	Scale Correction	45
7.1.9	Reduction Formulas	47
7.2	Conformity to National Regulations	48
7.2.1	Instrument	48
7.2.2	ZRT81	49
<b>8</b>	<b>Software Licence Agreement</b>	<b>50</b>
<b>Index</b>		<b>51</b>

# 1 Description of the System

## 1.1 System Components

### Main components

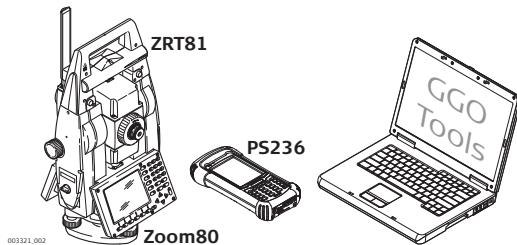

Component	Description
Zoom80	<ul style="list-style-type: none"> <li>an instrument for measuring, calculating and capturing data.</li> <li>comprised of various models with a range of accuracy classes.</li> <li>combined with Getac handheld to conduct remote control surveys.</li> <li>connected with GGO to view, exchange and manage data.</li> </ul>
Getac handheld	A multi-purpose handheld with long-range Bluetooth cap enabling the remote control of Zoom80.
ZRT81	Long-range Bluetooth device used on Zoom80 for communication to Getac handheld.
GGO	An office software consisting of a suite of standard and extended programs for the viewing, exchange and management of data.

### Terminology

The following terms and abbreviations may be found in this manual:

Term	Description
TPS	Total Station Positioning System
GGO	GeoMax Geo Office
EDM	<p><b>E</b>lectronic <b>D</b>istance <b>M</b>easurement</p> <p>EDM refers to the laser distancer incorporated into the instrument which enables distance measurement.</p> <p>Three measuring modes are available:</p> <ul style="list-style-type: none"> <li><b>IR</b> mode. This mode refers to the ability to measure distances to prisms.</li> <li><b>RL</b> mode. This mode refers to the ability to measure distances without prisms.</li> <li><b>LO</b> mode. This mode refers to the visible red laser and the ability to measure extended distances to prisms.</li> </ul>
accXess10	accXess10 refers to the Reflectorless EDM technology which enables an increased measuring range with a smaller laser spot size.
NavLight	A Navigation Light fitted to an instrument assists with prism targeting. It consists of two differently coloured flashing lights located in the instrument telescope housing. The person holding the prism can align him/herself into the instrument's line of sight.
Aim360	Aim360 refers to the instrument sensor which enables the automatic fine pointing to a prism.
Automation	<p>Three automation modes are available:</p> <ul style="list-style-type: none"> <li>None: - no automation and no tracking.</li> <li>Aim360: automatic fine pointing to a prism.</li> <li>Track360: automatic tracking of an already targeted prism.</li> </ul>
Scout360	Scout360 refers to the instrument sensor which enables the automatic rapid finding of a prism.
ZRT81	A component for remote control is ZRT81. It is both an integrated long-range Bluetooth modem with attached antenna and instrument carry handle.

## Instrument models

Model	Description
Zoom80 S	Reflectorless EDM, Aim360, Track360.
Zoom80 R	Reflectorless EDM, Aim360, Track360, Scout360.

## GGO

The program package GGO is used for the data exchange between the instrument and a computer. It contains several auxiliary programs in order to support the instrument.



For more information about GGO refer to the comprehensive online help.

## 1.2

### System Concept

#### 1.2.1

#### Software Concept

##### Description

All instruments use the same software concept.

##### Software type

Software type	Description
System software	This software comprises the central functions of the instrument. It is also referred to as firmware. The programs Survey and Setup are integrated into the firmware and cannot be deleted. The English language is integrated into the firmware and cannot be deleted.
Language software	Numerous languages are available for the instruments. This software is also referred to as system language. The system software enables a maximum of three languages which can be stored at any one time - the English language and two other languages. The English language is the default language and cannot be deleted. One language is chosen as the active language.
Application programs	A suite of optional survey-specific application programs is available for the instrument. Some of the programs are activated freely and require no license key and others require purchasing and are only activated with a license key.

##### Software upload

All instrument software is stored in the System RAM of the instrument. The software can be uploaded onto the instrument using the following methods:

- Using GGO the software is transferred via the serial interface to the CompactFlash card in the instrument, which is then stored to the System RAM.
  - By connecting the CompactFlash card directly to the computer either via an internal card slot housing or an external drive, the software is transferred to the card, which is then stored to the System RAM.
-  Uploading firmware can take some time. Ensure that the battery is at least 75% full before beginning the upload, and do not remove the battery during the upload process.

#### 1.2.2

#### Power Concept

##### General

Use the GeoMax batteries, chargers and accessories or accessories recommended by GeoMax to ensure the correct functionality of the instrument.

##### Power options

Type	Power supply
Instrument	One ZBA400 battery fitting into the instrument

### 1.2.3

## Data Storage and Data Conversion Concept

#### Description

Data is stored within a job in a database on a CompactFlash card.

#### Memory device

CompactFlash card:

A CompactFlash card housing is standard. A CompactFlash card can be inserted and removed. Available capacity: 256 MB.



Whilst other CompactFlash cards may be used, GeoMax recommends GeoMax CompactFlash cards and cannot be held responsible for data loss or any other error that may occur when using a non-GeoMax card.



Unplugging connecting cables or removing the CompactFlash card during the measurement may cause loss of data. Always return to the **Main Menu** before removing the CompactFlash card and switch off the instrument before removing cables.

#### Data conversion

##### Export

Job data can be exported from a job in a variety of file types. A format can be defined in GGO Format Manager. Refer to the online help of GGO Format Manager for information on creating format files.

##### Import

Data can be imported from ASCII, DXF, GSI8 or GSI16 format.

#### Transfer raw data to GGO

Raw data can be transferred between the database on the CompactFlash card and GGO in two ways:

- From the CompactFlash card directly via a serial interface to a project in GGO on a PC.
- From the CompactFlash card using for example a card reader to a project in GGO on a PC.



For Zoom80 CompactFlash cards can directly be used in an external drive. Some PC card drives can require an adaptor.

### 1.3

## Container Contents

#### Container for instrument and accessories

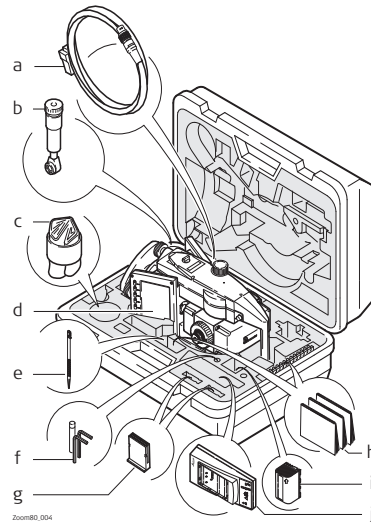

- a) Data transfer cable
- b) ZDE100 diagonal eyepiece
- c) Protective cover for instrument
- d) Instrument with tribrach and ZRT81
- e) Spare stylus
- f) Allen key
- g) CompactFlash cards and covers
- h) User manuals
- i) ZBA400 Battery
- j) ZCH201 battery charger

# 1.4

## Components

### 1.4.1

### Instrument

#### Instrument components part 1 of 2

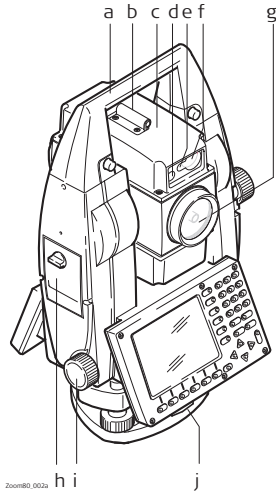

- a) Carry handle
- b) Optical sight
- c) Telescope, integrating EDM, Aim360
- d) NavLight flashing diode - yellow and red
- e) Scout360, transmitter
- f) Scout360, receiver
- g) Coaxial optics for angle and distance measurement, and exit port of visible laser beam for distance measurements
- h) CompactFlash card compartment
- i) Horizontal drive
- j) Tribrach securing screw

#### Instrument components part 2 of 2

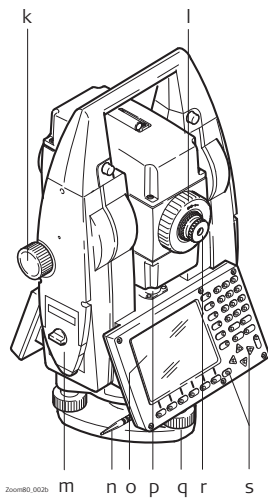

- k) Vertical drive
- l) Focusing ring
- m) Battery compartment
- n) Stylus for touch screen
- o) Screen
- p) Circular level
- q) Tribrach footscrew
- r) Interchangeable eyepiece
- s) Keyboard

#### Instrument components for communication

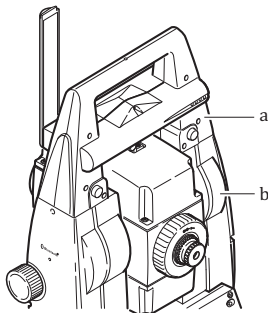

- a) ZRT81 handle
- b) Bluetooth port



2 **User Interface**  
 2.1 **Keyboard**  
 2.1.1 **Instrument**

**Keyboard**

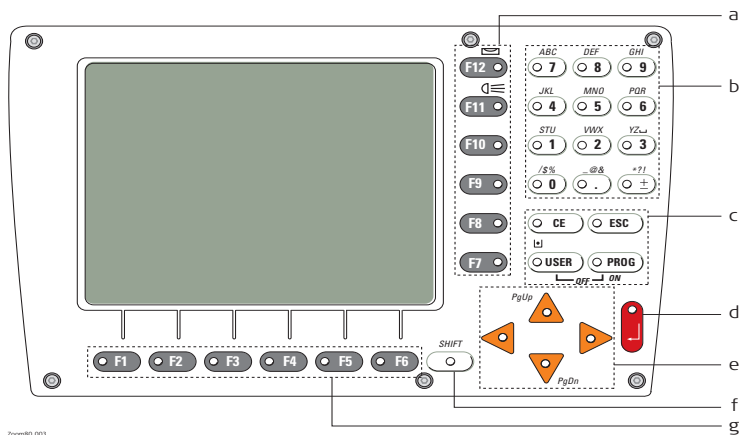

Zoom80\_003

- a) Hot keys **F7-F12**
- b) Alphanumeric keys
- c) CE, ESC, USER, PROG
- d) **ENTER**
- e) Arrow keys
- f) **SHIFT**
- g) Function keys **F1-F6**

**Keys**

Key	Description
Hot keys <b>F7-F12</b>	<ul style="list-style-type: none"> <li>User definable keys to execute commands or access chosen screens.</li> </ul>
Alphanumeric keys	<ul style="list-style-type: none"> <li>To type letters and numbers.</li> </ul>
<b>CE</b>	<ul style="list-style-type: none"> <li>Clears all entry at the beginning of user input.</li> <li>Clears the last character during user input.</li> </ul>
<b>ESC</b>	<ul style="list-style-type: none"> <li>Leaves the current menu or dialog without storing changes made.</li> </ul>
<b>USER</b>	<ul style="list-style-type: none"> <li>Calls the user-defined menu.</li> </ul>
<b>PROG (ON)</b>	<ul style="list-style-type: none"> <li>If the instrument is off: to turn instrument on.</li> <li>If the instrument is on: press at any time to select an application program.</li> </ul>
<b>ENTER</b>	<ul style="list-style-type: none"> <li>Selects the highlighted line and leads to the next logical dialog/menu.</li> <li>Starts the edit mode for edit fields.</li> <li>Opens a list box.</li> </ul>
<b>SHIFT</b>	<ul style="list-style-type: none"> <li>Changes between the first and the second level of function keys.</li> </ul>
<b>Arrow keys</b>	<ul style="list-style-type: none"> <li>Move the focus on the screen.</li> </ul>
Function keys <b>F1-F6</b>	<ul style="list-style-type: none"> <li>Correspond to the six softkeys that appear on the bottom of the screen when the screen is activated.</li> </ul>

**Key combinations**

Keys	Description
<b>PROG plus USER</b>	Turns instrument off.
<b>SHIFT F12</b>	Calls <b>STATUS Level &amp; Laser Plummet</b> .
<b>SHIFT (F11)</b>	Calls <b>CONFIGURE Lights, Display, Beeps, Text, Lights</b> page.
<b>SHIFT USER</b>	Calls <b>QUICK SET Change Settings to:</b> .
<b>SHIFT ▲</b>	Pages up.
<b>SHIFT ▼</b>	Pages down.

Screen

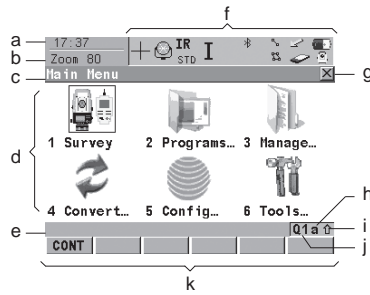

- a) Time
- b) Caption
- c) Title
- d) Screen area
- e) Message line
- f) Icons
- g) ESC ☒
- h) CAPS
- i) SHIFT icon
- j) Quick coding icon
- k) Softkeys

Elements of the screen

Element	Description
Time	The current local time is shown.
Caption	Shows location either in <b>Main Menu</b> , under <b>PROG</b> key or <b>USER</b> key.
Title	Name of the screen is shown.
Screen area	The working area of the screen.
Message line	Messages are shown for 10 s.
Icons	Shows current status information of the instrument. Refer to "2.4 Icons". Can be used with touch screen.
ESC ☒	Can be used with touch screen. Same functionality as the fixed key <b>ESC</b> . The last operation will be undone.
CAPS	The caps mode for upper case letters is active. The caps mode is activated and deactivated by pressing <b>UPPER(F5)</b> or <b>LOWER(F5)</b> in some screens.
SHIFT icon	Shows the status of the <b>SHIFT</b> key; either first or second level of softkeys is selected. Can be used with touch screen and has the same functionality as the fixed key <b>SHIFT</b> .
Quick coding icon	Shows the quick coding configuration. Can be used with touch screen to turn quick coding on and off.
Softkeys	Commands can be executed using <b>(F1)-(F6)</b> keys. The commands assigned to the softkeys are screen-dependent. Can be used directly with touch screen.
Scroll bar	Scrolls the screen area up and down.

2.3

Operating Principles

Keyboard and touch screen

The user interface is operated either by the keyboard or by the touch screen with supplied stylus. The workflow is the same for keyboard and touch screen entry, the only difference lies in the way information is selected and entered.

Selecting from a menu

Appearance	Description
<p>The screenshot shows a menu titled 'Management' with four items: 1 Jobs, 2 Data, 3 Code lists, and 4 Configuration Sets. The 'Jobs' item is highlighted.</p>	<p>To select an item from a menu, do one of the following:</p> <ul style="list-style-type: none"> <li>Move the focus to the item. <b>ENTER</b> or <b>CONT (F1)</b>.</li> </ul> <p>OR</p> <ul style="list-style-type: none"> <li>Type the complete selection number in front of the item. <b>ENTER</b> or <b>CONT (F1)</b> are not required.</li> </ul> <p>OR</p> <ul style="list-style-type: none"> <li>Tap on the item with the stylus.</li> </ul>

Edit an entire value in input fields

Appearance	Description
<p>The screenshot shows an input field labeled 'Point ID' with the value '001' entered. The field is highlighted.</p>	<ol style="list-style-type: none"> <li>1) Highlight the field.</li> <li>2) Type numeric and/or alphanumeric characters to overwrite.</li> <li>3) <b>ENTER</b> or tap outside of the field.</li> </ol>

## Selecting a page

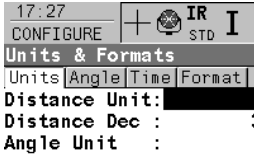
Appearance	Description
	<p>To select a page in a screen, do one of the following:</p> <p><b>PAGE (F6).</b></p> <p>OR</p> <p>Tap on the page tab with the stylus.</p>

## Edit an individual character in input fields

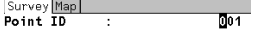
Appearance	Description
	<p>A character can be inserted or overwritten. The procedure is the same for both cases.</p> <ol style="list-style-type: none"> <li>1) Highlight the field.</li> <li>1) For the keyboard: <b>ENTER</b>. The edit mode is activated where additional functions like insert and overwrite are available.</li> <li>1) For the touch screen: Highlight the characters to be changed.</li> <li>1) Type numeric and/or alphanumeric characters.</li> <li>1) <b>ENTER</b> or tap outside of the field.</li> </ol>



## Access special alphanumeric characters for input

Step	Description
1.	Highlight the input field.
2.	For the keyboard: <b>ENTER</b> .
3.	Toggle to the desired special character set by using the up/down arrow keys.
4.	Press the function key assigned to the required character group.
5.	Press the function key with the required character.
6.	Repeat step 4. and 5. for entering more special characters of the same character set.
7.	<b>ENTER</b> .

## Appearance and selection from a choicelist

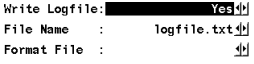

Choicelists have various appearances.

### Closed choicelist

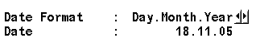

Appearance	Description	Selection
	Triangles on the right indicate further available choices.	Use the arrow keys   to change through the list or tap the triangles on the screen.

**ENTER** or tap on the field to access the choicelist. Opening a choicelist reveals either a simple listbox or a comprehensive listbox dialog.

### Simple listbox

Appearance	Description	Selection
	<ul style="list-style-type: none"> <li>• Choicelist shows items to select.</li> <li>• A search field is shown if necessary.</li> <li>• A scroll bar is shown if necessary.</li> </ul>	<ul style="list-style-type: none"> <li>• Highlight the item and <b>ENTER</b>.</li> <li>• To exit without changes <b>ESC</b>, tap  or outside the simple listbox.</li> </ul>

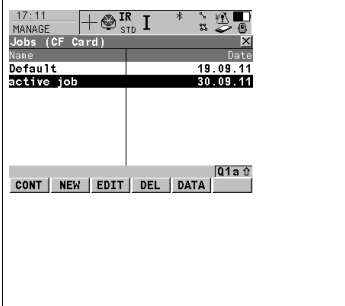
## Listbox dialog

Appearance	Description	Selection
	<ul style="list-style-type: none"> <li>• Choicelist fills the whole screen.</li> <li>• A search field is shown.</li> <li>• A scroll bar is shown if necessary.</li> <li>• The functionality comprises adding, editing and deleting of items.</li> <li>• Listbox dialogs are explained in detail at appropriate places in the manuals.</li> </ul>	<ul style="list-style-type: none"> <li>• Highlight the item and <b>CONT (F1)</b>.</li> <li>• To exit without changes press <b>ESC</b> or tap .</li> </ul>

### 2.3.1

## Instrument

### Turn instrument on

Press and hold **PROG** for 2 s.

### Turn instrument off step-by-step

Step	Description
	The instrument can only be turned off in the <b>Main Menu</b> .
1.	Press and hold both <b>USER</b> and <b>PROG</b> simultaneously. OR Press <b>ESC</b> for more than 2 s.
2.	Press <b>YES (F6)</b> to continue or <b>NO (F4)</b> to cancel.

### Lock/Unlock keyboard

Option	Description
Lock	To lock the keyboard press and hold <b>SHIFT</b> for 3 s. The message 'Keyboard locked' is momentarily displayed on the Message Line.
Unlock	To unlock the keyboard press and hold <b>SHIFT</b> for 3 s. The message 'Keyboard unlocked' is momentarily displayed on the Message Line.

## Description

The screen icons display the status information of the instrument.

## Position of the icons on the screen

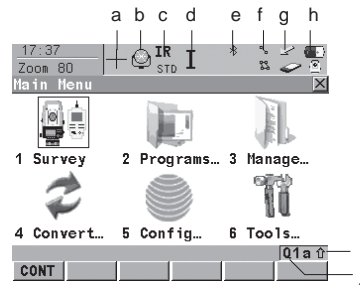

- a) Aim360/Track360/Scout360
- b) Reflector
- c) EDM
- d) Compensator/face I&I
- e) Bluetooth
- f) Line/area
- g) CompactFlash card
- h) Battery
- i) **SHIFT**
- j) Quick coding

## Icons

Icon	Description
<b>Aim360/Track360/Scout360</b>	The currently active Aim360/Track360/Scout360 settings or searches are displayed.
<b>Reflector</b>	The currently active reflector is displayed.
<b>EDM</b>	The currently active EDM measurement settings are displayed.
<b>Compensator/face I&amp;I</b>	Compensator off, out of range or face I&I icon is displayed.
<b>Remote control</b>	Remote control is turned on.
<b>Bluetooth</b>	The status of each Bluetooth port and any Bluetooth connection is displayed.
<b>Line/area</b>	The number of lines and areas currently open in the active job is displayed.
<b>CompactFlash card</b>	The status of the CompactFlash card is displayed. <ul style="list-style-type: none"> <li>For the CompactFlash card, the capacity of used space is shown in seven levels.</li> </ul>
<b>Battery</b>	The status and source of the battery is displayed. The percentage of remaining power capacity for all batteries is displayed numerically and graphically. For internal and external battery being attached at the same time the internal battery is used until it is empty and then the external battery is used.
<b>SHIFT</b>	The status of the <b>SHIFT</b> key is displayed.
<b>Quick coding</b>	Shows the quick coding configuration. Can be used with touch screen to turn quick coding on and off.

# 3

## Operation

### 3.1

### Instrument Setup

#### Description

This topic describes an instrument setup over a marked ground point using the laser plummet. It is always possible to set up the instrument without the need for a marked ground point.



#### Important features

- It is always recommended to shield the instrument from direct sunlight and avoid uneven temperatures around the instrument.
- The laser plummet described in this topic is built into the vertical axis of the instrument. It projects a red spot onto the ground, making it appreciably easier to centre the instrument.
- The laser plummet cannot be used with a tribrach equipped with an optical plummet.

#### Setup step-by-step

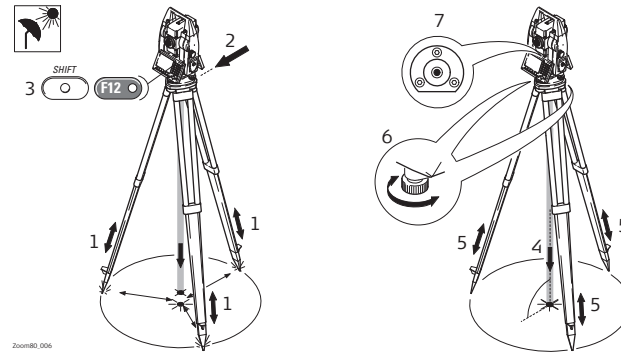

Step	Description
	Shield the instrument from direct sunlight and avoid uneven temperatures around the instrument.
1.	Extend the tripod legs to allow for a comfortable working posture. Position the tripod over the marked ground point, centring it as well as possible.
2.	Fasten the tribrach and instrument onto the tripod.
3.	Turn on the instrument by pressing <b>PROG</b> for 2 s. Press <b>SHIFT</b> (F12) to access <b>STATUS Level &amp; Laser Plummet</b> , activating the laser plummet.
4.	Move the tripod legs (1) and use the tribrach footscrews (6) to centre the plummet (4) over the ground point.
5.	Adjust the tripod legs to level the circular level (7).
6.	By using the electronic level turn the tribrach footscrews (6) to precisely level the instrument.
7.	Centre the instrument precisely over the ground point (4) by shifting the tribrach on the tripod plate (2).
8.	Repeat steps 6. and 7. until the required accuracy is achieved.

### 3.2

## Instrument Setup for Remote Control

### 3.2.1

### Remote Control Setup

Attaching the ZRT81 to the instrument

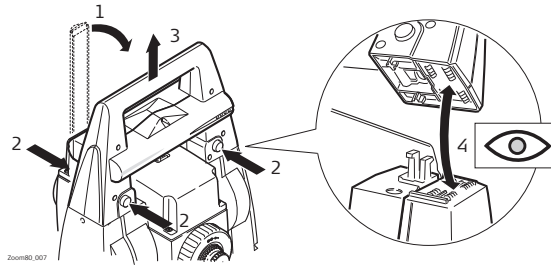

Step	Description
	Refer to "3.1 Instrument Setup" for the initial instrument setup onto a tripod. Remove the instrument carry handle by simultaneously pressing and holding-in the four push buttons.
1.	Place the ZRT81 onto the instrument by simultaneously pressing and holding-in the four push buttons.
	Ensure that the interface connection on the underside of the ZRT81 is on the same side as the Bluetooth port.
2.	Swing the ZRT81 antenna into an upright position.

Instrument setup for Remote Control

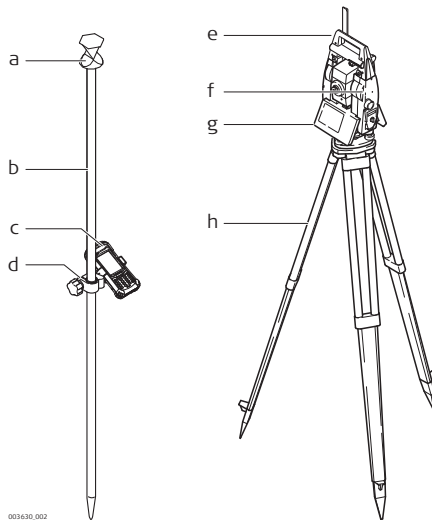

- a) 360° prism
- b) Prism pole
- c) Getac handheld
- d) ZHR200 holder
- e) ZRT81 handle
- f) Bluetooth port
- g) Zoom80 instrument
- h) Tripod

### 3.2.2

## LED Indicators on ZRT81

### LED Indicators

#### Description

The ZRT81 has Light Emitting Diode indicators. They indicate the basic ZRT81 status.

#### Diagram of the LED Indicators

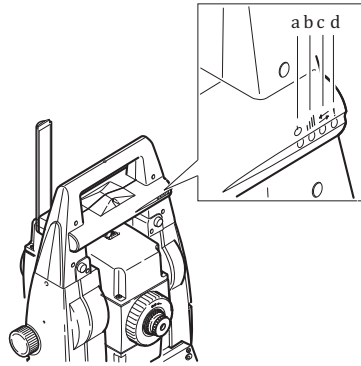

- a) Power LED
- b) Link LED
- c) Data Transfer LED
- d) Mode LED

#### Description of the LED Indicators

IF the	is	THEN
Power LED	off	power is off.
	green	power is on.
Link LED	off	no radio link to remote controller.
	red	radio link to remote controller.
Data Transfer LED	off	no data transfer to/from remote controller.
	green or green flashing	data transfer to/from remote controller.
Mode LED	off	data mode.
	red	configuration mode.

## 3.3

### Autodetect Behaviour

#### Description

- The instrument incorporates an autodetect behaviour and automatically detects the following device:
  - ZRT81
- Whenever a device is attached, the instrument responds with two short beeps.
- Whenever a device is removed, the instrument responds with one long beep.

#### ZRT81

- ZRT81 is automatically detected by the instrument when it is attached and the port configured.



### 3.4

## Fixing the handheld to a holder and pole

### Components of the ZHR200 holder

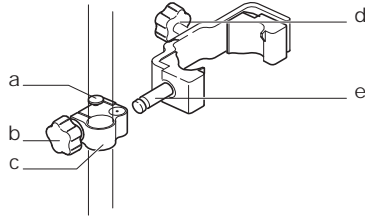

#### Clamp

- a) Locking pin
- b) Tightening screw
- c) Pole clamp

#### Holder

- d) Tightening screw
- e) Pin

### Fixing the handheld to the holder step-by-step

Step	Description
1.	Insert the pole into the clamp hole.
2.	Tighten the clamp with the tightening screw.
3.	To attach the holder to the clamp insert the pin into the catch of the clamp while pushing down the locking pin.
4.	Place the handheld in the holder.
5.	Tighten the screw of the holder to fix the handheld to the holder.

### 3.5

## Batteries

### 3.5.1

## Operating Principles

#### Charging / first-time use

- The battery must be charged prior to using it for the first time because it is delivered with an energy content as low as possible.
- The permissible temperature range for charging is between 0°C to +40°C/+32°F to +104°F. For optimal charging we recommend charging the batteries at a low ambient temperature of +10°C to +20°C/+50°F to +68°F if possible.
- It is normal for the battery to become warm during charging. Using the chargers recommended by GeoMax, it is not possible to charge the battery if the temperature is too high.
- For new batteries or batteries that have been stored for a long time (> three months), it is effectual to make only one charge/discharge cycle.
- For Li-Ion batteries, a single discharging and charging cycle is sufficient. We recommend carrying out the process when the battery capacity indicated on the charger or on a GeoMax product deviates significantly from the actual battery capacity available.

#### Operation / Discharging

- The batteries can be operated from -20°C to +55°C/-4°F to +131°F.
- Low operating temperatures reduce the capacity that can be drawn; high operating temperatures reduce the service life of the battery.

Insert and remove battery step-by-step

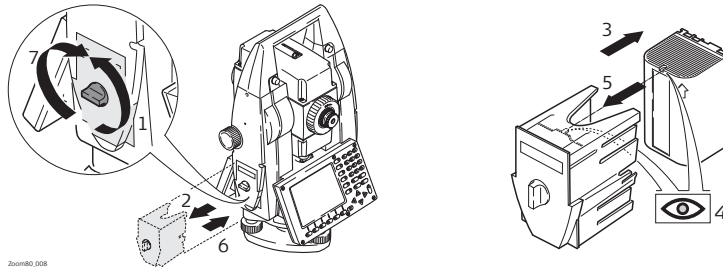

Step	Description
1.	Face the instrument so that the vertical drive screw is on the left. The battery compartment is now on the left side of the instrument. Turn the knob to the vertical position, opening the lid of the battery compartment.
2.	Pull out the battery housing.
3.	Pull the battery from the battery housing.
4.	A pictogram of the battery is displayed inside the battery housing. This is a visual aid to assist in placing the battery correctly.
5.	Place the battery into the battery housing, ensuring that the contacts are facing outward. Click the battery into position.
6.	Place the battery housing into the battery compartment. Push the battery housing in until it fits completely into the battery compartment.
7.	Turn the knob to lock the battery compartment. Ensure that the knob is returned to its original horizontal position.

### 3.6

## Working with the CompactFlash Card



- Keep the card dry.
- Use it only within the specified temperature range.
- Do not bend the card.
- Protect the card from direct impacts.



Failure to follow these instructions could result in data loss and/or permanent damage to the card.



Recommendations to prevent corrupt measurement data that cannot be imported into GGO:

- Format the CF card on a regular base.
- Do NOT remove the battery during operation. Always shut down the instrument by pressing the OFF key.
- Do NOT use the battery until it is completely empty resulting in an irregular shutdown of the instrument.

### 3.6.1

## Instrument

### Insert and remove a CompactFlash card step-by-step

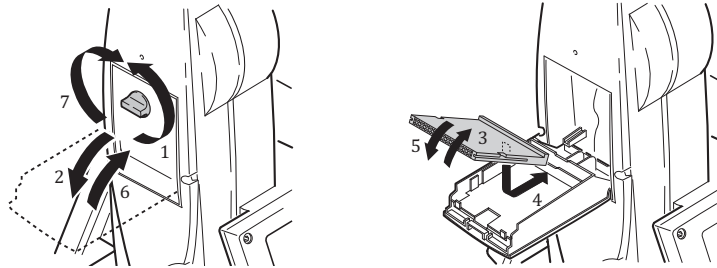

Step	Description
1.	Face the instrument so that the vertical drive screw is on the left. The CompactFlash card compartment is now on the right side of the instrument. Turn the knob to the vertical position, opening the lid of the CompactFlash card compartment.
2.	Open the lid of the CompactFlash card compartment.
3.	Pull the front of the CompactFlash card up and take the card out of the lid.
4.	Place the lower end of the CompactFlash card at the lower end of the CompactFlash card compartment. The extended edge of the card has to be on the upper side as shown on the pictogram in the CompactFlash card compartment.
5.	Press the card down on the lid.
6.	Close the lid.
7.	Turn the knob to lock the CompactFlash card compartment. The lid is closed correctly when the knob is turned to a horizontal position.

### Format a CompactFlash card step-by-step

Formatting the CompactFlash card before starting to store data is required if a completely new CompactFlash card is used or if all existing data needs to be deleted.

Step	Description
1.	<b>Main Menu: Tools...Format Memory Device.</b>
2.	<b>TOOLS Format Memory Device</b> <b>&lt;Memory Device: CF Card&gt;</b> <b>&lt;Format Method: Format Quick&gt;</b> Select the memory device to be formatted.
	By activating the format command all data will be lost. Make sure that all important data on the CompactFlash card has been backed up before formatting the card. Before formatting the internal memory make sure that all important data is first transferred to the PC.
	To exit the screen without formatting the memory device, press ESC. This returns to the previous screen without execution of any command.
3.	<b>CONT (F1).</b>
4.	<b>YES (F4)</b> to complete the formatting of the CompactFlash card.
	<b>NO (F6)</b> to abort the formatting of the CompactFlash card and return to <b>TOOLS Format Memory Device.</b>
5.	Once the formatting of the CompactFlash card is completed the system returns to the <b>Main Menu.</b>

Access

Select **Main Menu: Survey**.  
 OR  
 Press **PROG**. Highlight **Survey**. **CONT (F1)**.

**SURVEY**  
**Survey Begin**

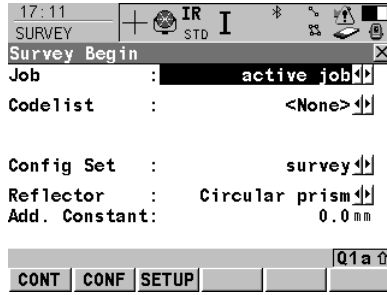

- CONT (F1)**  
 To accept changes and access the subsequent screen. The chosen settings become active.
- CONF (F2)**  
 To access **SURVEY Configuration**.
- SETUP (F3)**  
 Opens **SETUP Station Setup** to set station and orientation.

Description of fields

Field	Option	Description
<Job:>	Choicelist	The active job. All jobs from <b>Main Menu: Manage...Jobs</b> can be selected.
<Codelist:>	Choicelist Output	No codes are stored in the selected <Job:>. All codelists from <b>Main Menu: Manage...Codelists</b> can be selected. Codes have already been stored in the selected <Job:>. If codes had been copied from a System RAM codelist, then the name of the codelist is displayed. If codes have not been copied from a System RAM codelist but typed in manually, then the name of the active job is displayed.
<Config Set:>	Choicelist	The active configuration set. All configuration sets from <b>Main Menu: Manage...Configuration Sets</b> can be selected. The instrument has numerous user configuration parameters and functions. This allows a variety of preferences to be addressed. The configuration of the parameters and functions for an individual measuring technique are combined in a configuration set.
<Reflector:>	Choicelist	Displays the active reflector. All reflectors from <b>Main Menu: Manage...Reflectors</b> . All listed reflectors can be selected.
<Add. Constant:>	Output	Displays the additive constant stored with the chosen reflector.

Next step

**CONT (F1)** to access **SURVEY Survey: Job Name**, where measurements can be performed with **ALL (F1)** or **DIST (F2)** and/or **REC (F3)**.



Very short distances may be measured reflectorless in IR mode to well reflecting targets. Note that the distances are corrected with the additive constant defined for the active reflector.

Distance measurement

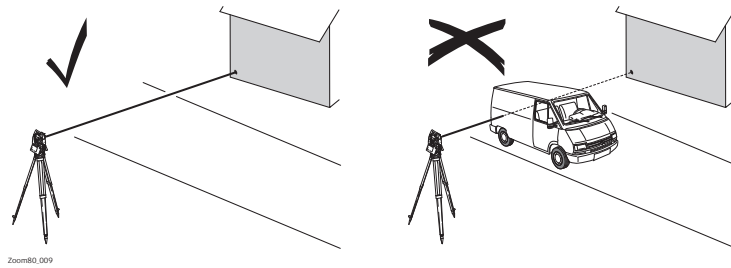

When measurements are being made using the red laser EDM, the results can be influenced by objects passing between the EDM and the intended target surface. This occurs because reflectorless measurements are made to the first surface returning sufficient energy to allow the measurement to take place. For example, if the intended target surface is the surface of a building, but a vehicle passes between the EDM and the target surface as the measurement is triggered, the measurement may be made to the side of the vehicle. The result is the distance to the vehicle, not to the surface of the building. If using the long range measurement mode (> 1000 m, > 3300 ft) to prisms, and an object passes within 30 m of the EDM as the measurement is triggered, the distance measurement may be similarly effected due to the strength of the laser signal.



CAUTION

Due to laser safety regulations and measuring accuracy, using the Long Range Reflectorless EDM is only allowed to prisms that are more than 1000 m (3300 ft) away.



Accurate measurements to prisms should be made in IR mode.



When a distance measurement is triggered, the EDM measures to the object which is in the beam path at that moment. If a temporary obstruction, for example a passing vehicle, heavy rain, fog or snow is between the instrument and the point to be measured, the EDM may measure to the obstruction.



Do not measure with two instruments to the same target simultaneously to avoid getting mixed return signals.

Aim360/Track360

The Aim360 sensor permits automatic angle and distance measurements to prisms. The prism is sighted with the optical sight. After initiating a distance measurement, the instrument sights the prism centre automatically. Vertical and horizontal angles and the distance are measured to the centre of the prism. The Track360 mode enables the instrument to follow a moving prism.



As with all other instrument errors, the collimation error of the automatic aiming must be redetermined periodically. Refer to "4 Check & Adjust" about checking and adjusting instruments.



When a measurement is triggered while the prism is still moving, distance and angle measurements may not be made for the same position and coordinates may vary.



If the prism location is changed too quickly, the target may be lost. Make sure that the speed does not exceed the figure given in the technical data.

# 4 Check & Adjust

## 4.1 Overview

**Description** GeoMax instruments are manufactured, assembled and adjusted to a high quality. Quick temperature changes, shock or stress can cause deviations and decrease the instrument accuracy. It is therefore recommended to calibrate the instrument from time to time. This can be done in the field by running through specific measurement procedures. The procedures are guided and have to be followed carefully and precisely as described in the following chapters. Some other instrument errors and mechanical parts can be adjusted mechanically.

**Electronic adjustment** The following instrument errors can be checked and adjusted electronically:

l, t	Compensator longitudinal and transversal index errors
i	Vertical index error, related to the standing axis
c	Horizontal collimation error, also called line of sight error
a	Tilting axis error
Aim360	Aim360 zero point error for Hz and V - option

Every angle measured in the daily work is corrected automatically if the compensator and the Hz-corrections are activated in the instrument configuration. Select **Main Menu: Config...Instrument Settings...Compensator** to check the settings.

**View current adjustment errors** The currently used adjustment errors can be viewed under **Main Menu: Tools...Check & Adjust...Current Values**.

**Mechanical adjustment** The following instrument parts can be adjusted mechanically:

- Circular level on instrument and tribrach
- Laser plummet
- Optical plummet - option on tribrach
- Allen screws on tripod

**Precise measurements** To get precise measurements in the daily work, it is important:

- To check and adjust the instrument from time to time.
- To take high precision measurements during the check and adjust procedures.
- To measure targets in two faces. Some of the instrument errors are eliminated by averaging the angles from both faces.
- Refer to "4.2 Preparation" to find more important points.



During the manufacturing process, the instrument errors are carefully determined and set to zero. As mentioned above, these errors can change and it is highly recommended to redetermine them in the following situations:

- Before the first use
- Before every high precision survey
- After rough or long transportation
- After long working periods
- After long storage periods
- If the temperature difference between current environment and the temperature at the last calibration is more than 20°C

**Summary of errors to be adjusted electronically**

Instrument error	Effects Hz	Effects V	Elimination with two face measurement	Automatically corrected with proper adjustment
c - Line of sight error	✓	---	✓	✓
a - Tilting axis error	✓	---	✓	✓
l - Compensator index error	---	✓	✓	✓
t - Compensator index error	✓	---	✓	✓
i - Vertical index error	---	✓	✓	✓
Aim360 Collimation error	✓	✓	---	✓

## 4.2

## Preparation



Before determining the instrument errors, the instrument has to be levelled using the electronic level. **SHIFT (F12)** to access **STATUS Level & Laser Plummet, Level** page. The tribrach, the tripod and the underground should be stable and secure from vibrations or other disturbances.



The instrument should be protected from direct sunlight to avoid thermal warming. It is also recommended to avoid strong heat shimmer and air turbulence. The best conditions are early in the morning or with overcast sky.



Before starting to work, the instrument has to become acclimatised to the ambient temperature. Approximately two minutes per °C of temperature difference from storage to working environment, but at least 15 min, should be taken into account.



Even after adjustment of the Aim360, the crosshairs may not be positioned exactly on the centre of the prism after an Aim360 measurement has been completed. This outcome is a normal effect. The telescope is not normally positioned exactly on the centre of the prism, to speed up the Aim360 measurement. These small deviations/Aim360 offsets, are calculated individually for each measurement and corrected electronically. This means that the horizontal and vertical angles are corrected twice: first by the determined Aim360 errors for Hz and V, and then by the individual small deviations of the current aiming.

### Next step

IF the task is to	THEN
adjust a combination of instrument errors	Refer to "4.3 Combined Adjustment (l, t, i, c and Aim360)".
adjust the tilting axis	Refer to "4.4 Tilting Axis Adjustment (a)".
adjust the circular level	Refer to "4.5 Adjusting the Circular Level of the Instrument and Tribrach".
adjust the laser/optical plummet	Refer to "4.7 Inspecting the Laser Plummet of the Instrument".
adjust the tripod	Refer to "4.8 Servicing the Tripod".

## 4.3

## Combined Adjustment (l, t, i, c and Aim360)





### Description

The combined adjustment procedure determines the following instrument errors in one process:

l, t	Compensator longitudinal and transversal index errors
i	Vertical index error, related to the standing axis
c	Horizontal collimation error, also called line of sight error
Aim360 Hz	Aim360 zero point error for horizontal angle option
Aim360 V	Aim360 zero point error for vertical angle option

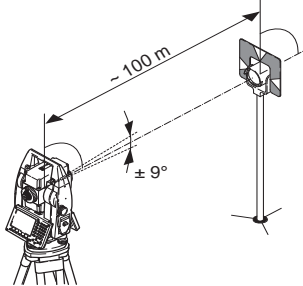
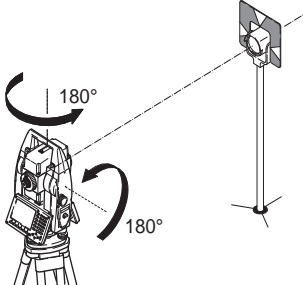
**Combined adjustment procedure step-by-step**

The following table explains the most common settings.

Step	Description
1.	<b>Main Menu: Tools... \ Check &amp; Adjust...</b>
2.	<b>TOOLS Check &amp; Adjust Menu</b> Select the option: <b>Combined (I,t,i,c,Aim)</b>
3.	<b>TOOLS Combined I</b> <b>&lt;Aim Adjust: On&gt;</b> Includes the determination of the Aim360 Hz and V adjustment errors.  It is recommended to use a clean GeoMax circular prism as target. Do not use a 360° prism.
4.	 Aim the telescope accurately at a target at about 100 m distant. The target must be positioned within $\pm 9^\circ / \pm 10$ gon of the horizontal plane. The procedure can be started in any telescope face.
5.	<b>MEAS (F1)</b> to measure and to continue to the next screen. Instruments change automatically to the other face.   The fine pointing has to be performed manually in both faces.
6.	<b>TOOLS Combined II</b> <b>MEAS (F1)</b> to measure the same target in the other face and to calculate the instrument errors.  If one or more errors are bigger than the predefined limits, the procedure has to be repeated. All measurements of the current run are rejected and none of them is averaged with the results from previous runs.
7.	<b>TOOLS Adjustment Accuracy</b> <b>&lt;No.of Meas:&gt;</b> Shows the number of runs executed. One run consists of a measurement in face I and face II. <b>&lt;<math>\sigma</math> I Comp:&gt;</b> and similar lines show the standard deviations of the determined adjustment errors. The standard deviations can be calculated from the second run onwards.  It is recommended to measure at least two runs.
8.	<b>MEAS (F5)</b> if more runs have to be added. Continue with step 3. OR <b>CONT (F1)</b> to accept the measurements and to proceed to <b>TOOLS Adjustment Results</b> . No more runs can be added later.

**Next step**

IF the results are	THEN
to be stored	<b>CONT (F1)</b> overwrites the old adjustment errors with the new ones, if the <b>Use</b> status is set to <b>Yes</b> .
to be determined again	<b>REDO (F2)</b> rejects all new determined adjustment errors and repeats the whole procedure. Refer to step 3. of paragraph "Combined adjustment procedure step-by-step".







**Description**

This adjustment procedure determines the following instrument error:  
 a Tilting axis error

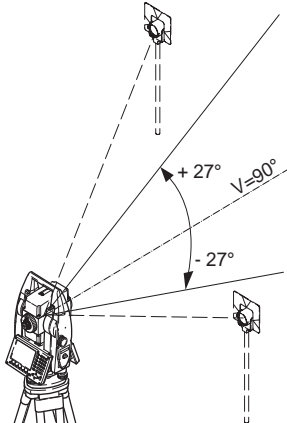
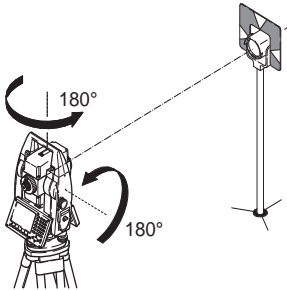
**Determination of tilting axis error step-by-step**

The following table explains the most common settings.

Step	Description
	The Hz collimation error (c) has to be determined before starting this procedure.
1.	<b>Main Menu: Tools... \Check &amp; Adjust...</b>
2.	<b>TOOLS Check &amp; Adjust Menu</b> Select the option: <b>Tilting Axis (a)</b>
3.	<p><b>TOOLS Tilting-Axis Adjustment I</b></p>  <p>Aim the telescope accurately at a target at about 100 m distance or less if not possible. The target must be positioned at least 27°/30 gon above or beneath the horizontal plane. The procedure can be started in any telescope face.</p>
4.	<p><b>MEAS (F1)</b> to measure and to continue to the next screen.                      Instruments change automatically to the other face.</p>  <p> The fine pointing has to be performed manually in both faces.</p>
5.	<p><b>TOOLS Tilting-Axis Adjustment II</b>  <b>MEAS (F1)</b> to measure the same target in the other face and to calculate the tilting axis error.</p>
	If the error is bigger than the predefined limit, the procedure has to be repeated. The tilting axis measurements of the current run are then rejected and not averaged with the results from previous runs.
6.	<p><b>TOOLS T-Axis Adjustment Accuracy</b></p> <p>&lt;No.of Meas:&gt; Shows the number of runs executed. One run consists of a measurement in face I and face II.</p> <p>&lt;<math>\sigma</math> a T-axis:&gt; shows the standard deviation of the determined tilting axis error. The standard deviation can be calculated from the second run onwards.</p>
	It is recommended to measure at least two runs.
7.	<p><b>MEAS (F5)</b> if more runs have to be added. Continue with step 3.                      OR  <b>CONT (F1)</b> to accept the measurements and to proceed to <b>TOOLS T-Axis Adjustment Result</b>. No more runs can be added later.</p>

Next step

IF the results are	THEN
to be stored	<b>CONT (F1)</b> overwrites the old tilting axis error with the new one.
to be determined again	<b>REDO (F2)</b> rejects the new determined tilting axis error and repeats the whole procedure. Refer to step of paragraph "Determination of tilting axis error step-by-step".

## 4.5 Adjusting the Circular Level of the Instrument and Tribrach

Adjusting the circular level step-by-step

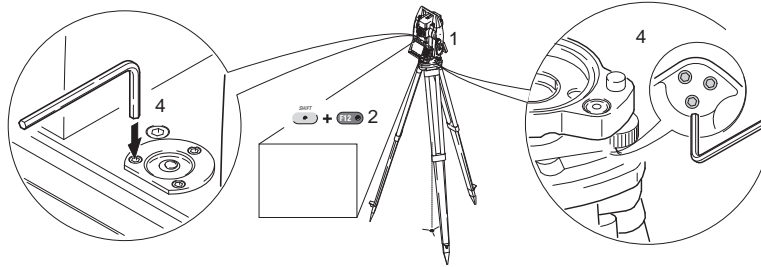

Step	Description
1.	Place and secure the instrument into the tribrach and onto a tripod.
2.	Using the tribrach footscrews, level the instrument with the electronic level. <b>SHIFT (F12)</b> to access <b>STATUS Level &amp; Laser Plummet</b> .
3.	Check the position of the circular level on the instrument and tribrach.
4.	<p>a) If both circular levels are centered, no adjustments are necessary.</p> <p>b) If one or both circular levels are not centered, adjust as follows:</p> <p><b>Instrument:</b> If it extends beyond the circle, use the supplied allen key to centre it with the adjustment screws. Turn the instrument by 200 gon (180°). Repeat the adjustment procedure if the circular level does not stay centered.</p> <p><b>Tribrach:</b> If it extends beyond the circle, use the supplied allen key to centre it with the adjustment screws.</p>
	After the adjustments, all adjusting screws should have the same tightening tension and no adjusting screw shall be loose.

## 4.6 Adjusting the Circular Level of the Prism Pole

Adjusting the circular level step-by-step

Step	Description
1.	Suspend a plumb line.
2.	Use a pole bipod, to align the prism pole parallel to the plumb line.
3.	Check the position of the circular level on the prism pole.
4.	<p>a) If the circular level is centred, no adjustment is necessary.</p> <p>b) If the circular level is not centred, use an allen key to centre it with the adjustment screws.</p>
	After the adjustments, all adjusting screws must have the same tightening tension and no adjusting screw should be loose.

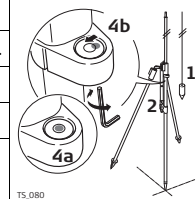

## 4.7

## Inspecting the Laser Plummet of the Instrument



The laser plummet is integrated into the vertical axis of the instrument. Under normal conditions of use, the laser plummet does not need adjusting. If an adjustment is necessary due to external influences, the instrument has to be returned to a GeoMax service workshop.

### Inspecting the laser plummet step-by-step

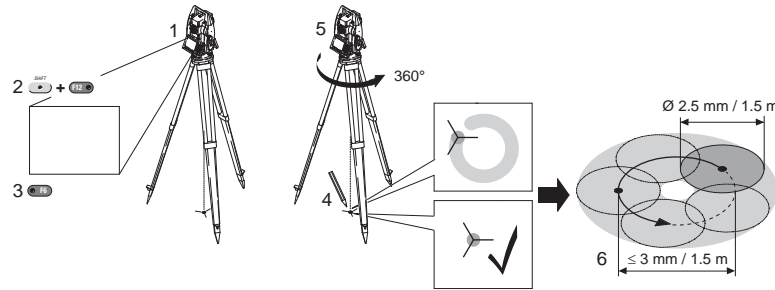

The following table explains the most common settings.

Step	Description
1.	Place and secure the instrument into the tribrach and onto a tripod.
2.	Using the tribrach footscrews, level the instrument with the electronic level. <b>SHIFT (F12)</b> to access <b>STATUS Level &amp; Laser Plummet</b> .
3.	<b>PAGE (F6)</b> to access the <b>Laser Plummet</b> page. Switch on the laser plummet. Inspection of the laser plummet should be carried out on a bright, smooth and horizontal surface, like a sheet of paper.
4.	Mark the centre of the red dot on the ground.
5.	Turn the instrument through 360° slowly, carefully observing the movement of the red laser dot.
	The maximum diameter of the circular movement described by the centre of the laser point should not exceed 3 mm at a distance of 1.5 m.
6.	If the centre of the laser dot describes a perceptible circular movement or moves more than 3 mm away from the point which was first marked, an adjustment may be required. Inform your nearest GeoMax authorised service workshop. Depending on brightness and surface, the diameter of the laser dot can vary. At 1.5 m it is about 2.5 mm.

## 4.8

## Servicing the Tripod

### Servicing the tripod step-by-step

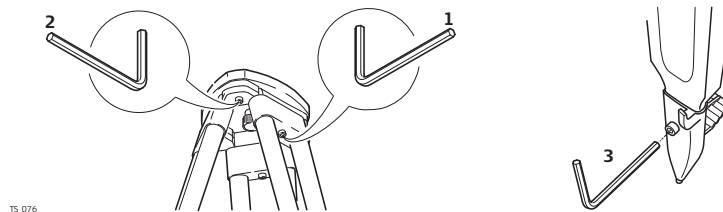

The following table explains the most common settings.

Step	Description
	The connections between metal and timber components must always be firm and tight.
1.	Tighten the leg cap screws moderately, with the supplied allen key.
2.	Tighten the articulated joints on the tripod head enough to keep the tripod legs open when lifting the tripod off the ground.
3.	Tighten the allen screws of the tripod legs.

## 5 Care and Transport

### 5.1 Transport

---

<b>Transport in the field</b>	When transporting the equipment in the field, always make sure that you <ul style="list-style-type: none"><li>• either carry the product in its original transport container,</li><li>• or carry the tripod with its legs splayed across your shoulder, keeping the attached product upright.</li></ul>
<b>Transport in a road vehicle</b>	Never carry the product loose in a road vehicle, as it can be affected by shock and vibration. Always carry the product in its transport container and secure it.
<b>Shipping</b>	When transporting the product by rail, air or sea, always use the complete original GeoMax packaging, transport container and cardboard box, or its equivalent, to protect against shock and vibration.
<b>Shipping, transport of batteries</b>	When transporting or shipping batteries, the person in charge of the product must ensure that the applicable national and international rules and regulations are observed. Before transportation or shipping, contact your local passenger or freight transport company.
<b>Field adjustment</b>	Periodically carry out test measurements and perform the field adjustments indicated in the User Manual, particularly after the product has been dropped, stored for long periods or transported.

---

### 5.2 Storage

---

<b>Product</b>	Respect the temperature limits when storing the equipment, particularly in summer if the equipment is inside a vehicle. Refer to "7 Technical Data" for information about temperature limits.
<b>Field adjustment</b>	After long periods of storage inspect the field adjustment parameters given in this user manual before using the product.
<b>Li-Ion batteries</b>	<ul style="list-style-type: none"><li>• Refer to "7 Technical Data" for information about storage temperature range.</li><li>• Remove batteries from the product and the charger before storing.</li><li>• After storage recharge batteries before using.</li><li>• Protect batteries from damp and wetness. Wet or damp batteries must be dried before storing or use.</li><li>• A storage temperature range of -20°C to +30°C/-4°F to 86°F in a dry environment is recommended to minimise self-discharging of the battery.</li><li>• At the recommended storage temperature range, batteries containing a 50% to 100% charge can be stored for up to one year. After this storage period the batteries must be recharged.</li></ul>

---

### 5.3 Cleaning and Drying

---

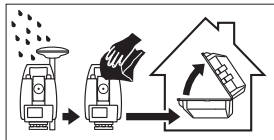
<b>Product and accessories</b>	<ul style="list-style-type: none"><li>• Blow dust off lenses and prisms.</li><li>• Never touch the glass with your fingers.</li><li>• Use only a clean, soft, lint-free cloth for cleaning. If necessary, moisten the cloth with water or pure alcohol. Do not use other liquids; these can attack the polymer components.</li></ul>
<b>Fogging of prisms</b>	Prisms that are cooler than the ambient temperature tend to fog. It is not enough simply to wipe them. Keep them for some time inside your jacket or in the vehicle to allow them to adjust to the ambient temperature.
<b>Damp products</b>	Dry the product, the transport container, the foam inserts and the accessories at a temperature not greater than 40°C/104°F and clean them. Do not repack until everything is dry. Always close the transport container when using in the field. 
<b>Cables and plugs</b>	Keep plugs clean and dry. Blow away any dirt lodged in the plugs of the connecting cables.

---

**Motorisation**

An inspection of the motorisation in motorised instruments must be done in a GeoMax authorised service workshop.

Following conditions:

- After about 4000 hours operation.
  - Twice a year in case of permanent use of the instrument.
-

# 6 Safety Directions

## 6.1 General Introduction

---

**Description** The following directions enable the person responsible for the product, and the person who actually uses the equipment, to anticipate and avoid operational hazards.

The person responsible for the product must ensure that all users understand these directions and adhere to them.

---

## 6.2 Definition of Use

### 6.2.1 Instrument

---

**Intended use**

- Measuring horizontal and vertical angles.
- Measuring distances.
- Recording measurements.
- Automatic target search, recognition and -tracking.
- Visualising the aiming direction and vertical axis.
- Remote control of product.
- Data communication with external appliances.
- Computing with software.

---

**Adverse use**

- Use of the product without instruction.
- Use outside of the intended limits.
- Disabling safety systems.
- Removal of hazard notices.
- Opening the product using tools, for example screwdriver, unless this is permitted for certain functions.
- Modification or conversion of the product.
- Use after misappropriation.
- Use of products with recognisable damages or defects.
- Use with accessories from other manufacturers without the prior explicit approval of GeoMax.
- Aiming directly into the sun.
- Inadequate safeguards at the working site, for example when measuring on roads.
- Deliberate dazzling of third parties.
- Controlling of machines, moving objects or similar monitoring application without additional control- and safety installations.

---

 **WARNING** Adverse use can lead to injury, malfunction and damage. It is the task of the person responsible for the equipment to inform the user about hazards and how to counteract them. The product is not to be operated until the user has been instructed on how to work with it.

---

## 6.3 Limits of Use

---

**Environment** Suitable for use in an atmosphere appropriate for permanent human habitation: not suitable for use in aggressive or explosive environments.

---

 **DANGER** Local safety authorities and safety experts must be contacted before working in hazardous areas, or close to electrical installations or similar situations by the person in charge of the product.

---

## 6.4

## Responsibilities

### Manufacturer of the product

GeoMax AG, CH-9443 Widnau, hereinafter referred to as GeoMax, is responsible for supplying the product, including the user manual and original accessories, in a safe condition.

### Person responsible for the product

The person responsible for the product has the following duties:

- To understand the safety instructions on the product and the instructions in the user manual.
- To ensure that it is used in accordance with the instructions.
- To be familiar with local regulations relating to safety and accident prevention.
- To inform GeoMax immediately if the product and the application becomes unsafe.
- To ensure that the national laws, regulations and conditions for the operation of e.g. radio transmitters, lasers are respected.

## 6.5

## Hazards of Use

### CAUTION

Watch out for erroneous measurement results if the product has been dropped or has been misused, modified, stored for long periods or transported.

**Precautions:**

Periodically carry out test measurements and perform the field adjustments indicated in the user manual, particularly after the product has been subjected to abnormal use and before and after important measurements.

### DANGER

Because of the risk of electrocution, it is dangerous to use poles and extensions in the vicinity of electrical installations such as power cables or electrical railways.

**Precautions:**

Keep at a safe distance from electrical installations. If it is essential to work in this environment, first contact the safety authorities responsible for the electrical installations and follow their instructions.



### NOTICE

With the remote control of products, it is possible that extraneous targets will be picked out and measured.

**Precautions:**

When measuring in remote control mode, always check your results for plausibility.

### CAUTION

Be careful when pointing the product towards the sun, because the telescope functions as a magnifying glass and can injure your eyes and/or cause damage inside the product.

**Precautions:**

Do not point the product directly at the sun.

### WARNING

During dynamic applications, for example stakeout procedures there is a danger of accidents occurring if the user does not pay attention to the environmental conditions around, for example obstacles, excavations or traffic.

**Precautions:**

The person responsible for the product must make all users fully aware of the existing dangers.

### WARNING

Inadequate securing of the working site can lead to dangerous situations, for example in traffic, on building sites, and at industrial installations.

**Precautions:**

Always ensure that the working site is adequately secured. Adhere to the regulations governing safety and accident prevention and road traffic.

### WARNING

If computers intended for use indoors are used in the field there is a danger of electric shock.

**Precautions:**

Adhere to the instructions given by the computer manufacturer regarding field use with GeoMax products.

### CAUTION

If the accessories used with the product are not properly secured and the product is subjected to mechanical shock, for example blows or falling, the product may be damaged or people can sustain injury.

**Precautions:**

When setting-up the product, make sure that the accessories are correctly adapted, fitted, secured, and locked in position.

Avoid subjecting the product to mechanical stress.

	<b>WARNING</b>	If the product is used with accessories, for example masts, staffs, poles, you may increase the risk of being struck by lightning. <b>Precautions:</b> Do not use the product in a thunderstorm.
	<b>CAUTION</b>	During the transport, shipping or disposal of batteries it is possible for inappropriate mechanical influences to constitute a fire hazard. <b>Precautions:</b> Before shipping the product or disposing of it, discharge the batteries by running the product until they are flat. When transporting or shipping batteries, the person in charge of the product must ensure that the applicable national and international rules and regulations are observed. Before transportation or shipping contact your local passenger or freight transport company.
	<b>WARNING</b>	High mechanical stress, high ambient temperatures or immersion into fluids can cause leakage, fire or explosions of the batteries. <b>Precautions:</b> Protect the batteries from mechanical influences and high ambient temperatures. Do not drop or immerse batteries into fluids.
	<b>WARNING</b>	If battery terminals are short circuited e.g. by coming in contact with jewellery, keys, metalized paper or other metals, the battery can overheat and cause injury or fire, for example by storing or transporting in pockets. <b>Precautions:</b> Make sure that the battery terminals do not come into contact with metallic objects.
	<b>WARNING</b>	If the product is improperly disposed of, the following can happen: <ul style="list-style-type: none"> <li>• If polymer parts are burnt, poisonous gases are produced which may impair health.</li> <li>• If batteries are damaged or are heated strongly, they can explode and cause poisoning, burning, corrosion or environmental contamination.</li> <li>• By disposing of the product irresponsibly you may enable unauthorised persons to use it in contravention of the regulations, exposing themselves and third parties to the risk of severe injury and rendering the environment liable to contamination.</li> </ul> <b>Precautions:</b>  <ul style="list-style-type: none"> <li>The product must not be disposed with household waste.</li> <li>Dispose of the product appropriately in accordance with the national regulations in force in your country.</li> <li>Always prevent access to the product by unauthorised personnel.</li> </ul> Product-specific treatment and waste management information is available from GeoMax AG.
	<b>WARNING</b>	Only GeoMax authorised service workshops are entitled to repair these products.

## 6.6

### 6.6.1

## Laser Classification

### General

#### General

The following chapters provide instructions and training information about laser safety according to international standard IEC 60825-1 (2007-03) and technical report IEC TR 60825-14 (2004-02). The information enables the person responsible for the product and the person who actually uses the equipment, to anticipate and avoid operational hazards.



According to IEC TR 60825-14 (2004-02), products classified as laser class 1, class 2 and class 3R do not require:

- laser safety officer involvement,
- protective clothes and eyewear,
- special warning signs in the laser working area



if used and operated as defined in this User Manual due to the low eye hazard level.

National laws and local regulations could impose more stringent instructions for the safe use of lasers than IEC 60825-1 (2007-03) and IEC TR 60825-14 (2004-02).



## 6.6.2

### Distancer, Measurements with Reflectors

#### General

The EDM module built into the product produces a visible laser beam which emerges from the telescope objective.

The laser product described in this section is classified as laser class 1 in accordance with:

- IEC 60825-1 (2007-03): "Safety of laser products"
- EN 60825-1 (2007-10): "Safety of laser products"

These products are safe under reasonably foreseeable conditions of operation and are not harmful to the eyes provided that the products are used and maintained in accordance with this User Manual.

Description	Value
Maximum average radiant power	0.33 mW
Pulse duration	800 ps
Pulse repetition frequency	100 MHz - 150 MHz
Wavelength	650 nm - 690 nm

#### Labelling

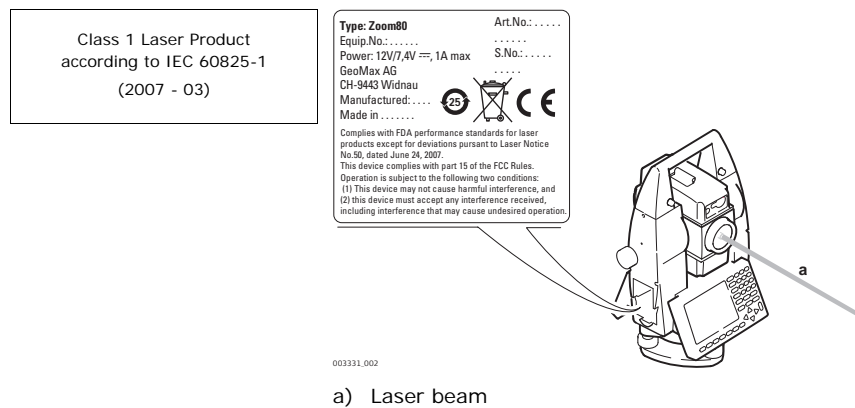

a) Laser beam

## 6.6.3

### Distancer, Measurements without Reflectors

#### General

The EDM module built into the product produces a visible laser beam which emerges from the telescope objective.

The laser product described in this section is classified as laser class 3R in accordance with:

- IEC 60825-1 (2007-03): "Safety of laser products"
- EN 60825-1 (2007-10): "Safety of laser products"

Class 3R laser products:

Direct intrabeam viewing may be hazardous (low eye hazard level), in particular for deliberate ocular exposure. The beam may cause dazzle, flash-blindness and after-images, particularly under low ambient light conditions. The risk of injury for laser class 3R products is limited because of:

- unintentional exposure would rarely reflect worst case conditions of (e.g.) beam alignment with the pupil, worst case accommodation,
- inherent safety margin in the maximum permissible exposure to laser radiation (MPE)
- natural aversion behaviour for exposure to bright light for the case of visible radiation.

Description	Value (R1000)
Maximum average radiant power	5.00 mW
Pulse duration	800 ps
Pulse repetition frequency	100 MHz - 150 MHz
Wavelength	650 nm - 690 nm
Beam divergence	0.2 mrad x 0.3 mrad
NOHD (Nominal Ocular Hazard Distance) @ 0.25s	80 m / 262 ft

**CAUTION**

From a safety perspective, class 3R laser products should be treated as potentially hazardous.

**Precautions:**

- 1) Prevent direct eye exposure to the beam.
- 2) Do not direct the beam at other people.

**CAUTION**

Potential hazards are not only related to direct beams but also to reflected beams aimed at reflecting surfaces such as prisms, windows, mirrors, metallic surfaces, and so on.

**Precautions:**

- 1) Do not aim at areas that are essentially reflective, such as a mirror, or which could emit unwanted reflections.
- 2) Do not look through or beside the optical sight at prisms or reflecting objects when the laser is switched on, in laser pointer or distance measurement mode. Aiming at prisms is only permitted when looking through the telescope.

**Labelling**

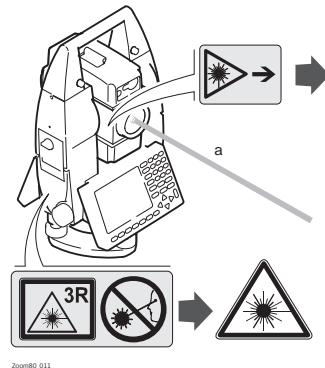

Zoom80\_011

a) Laser beam

Laser Aperture

Laser Radiation  
 Avoid direct eye exposure  
 Class 3R Laser Product  
 according to IEC 60825-1  
 (2007 - 03)  
 $P_o \leq 5.00 \text{ mW}$   
 $\lambda = 650 - 690 \text{ nm}$

Type: Zoom80 Art.No.: .....  
 Equip.No.: ..... S.No.: .....  
 Power: 12V/7.4V ~~, 1A max  
 GeoMax AG  
 CH-9443 Widnau  
 Manufactured: .....  
 Made in: .....  
 Complies with FDA performance standards for laser products except for deviations pursuant to Laser Notice No.50, dated June 24, 2007.  
 This device complies with part 15 of the FCC Rules. Operation is subject to the following two conditions:  
 (1) This device may not cause harmful interference, and  
 (2) this device must accept any interference received, including interference that may cause undesired operation.

003333\_002

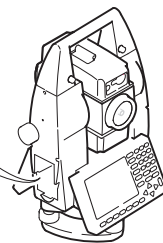

**6.6.4**

**Aim360**

**General**

The Aim360 built into the product produces an invisible laser beam which emerges from the telescope objective.

The laser product described in this section is classified as laser class 1 in accordance with:

- IEC 60825-1 (2007-03): "Safety of laser products"
- EN 60825-1 (2007-10): "Safety of laser products"

Class 1 laser products are safe under reasonably foreseeable conditions of operation and are not harmful to the eyes provided that the products are used and maintained in accordance with this User Manual.

Description	Value
Maximum average radiant power	10 mW
Pulse duration	11 ms
Pulse repetition frequency	37 Hz
Wavelength	785 nm

**Labelling**

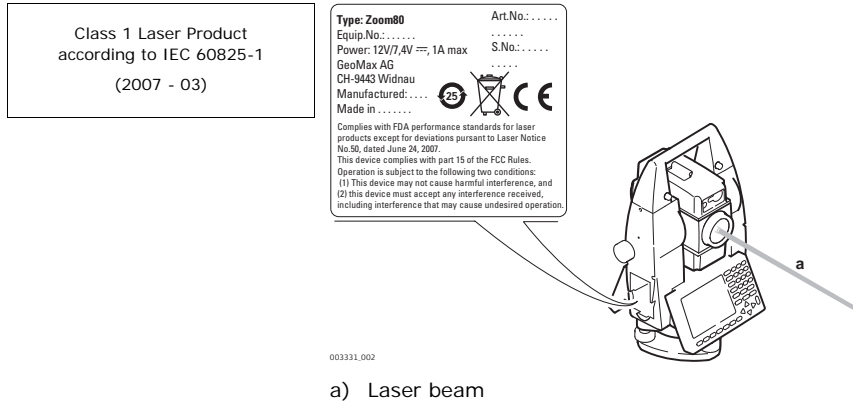

**6.6.5**

**Scout360**

**General**

The Scout360 built into the product produces an invisible laser beam which emerges from the front side of the telescope.

The laser product described in this section is classified as laser class 1 in accordance with:

- IEC 60825-1 (2007-03): "Safety of laser products"
- EN 60825-1 (2007-10): "Safety of laser products"

Class 1 laser products are safe under reasonably foreseeable conditions of operation and are not harmful to the eyes provided that the products are used and maintained in accordance with this User Manual.

Description	Value
Maximum average radiant power	11 mW
Pulse duration	20 ns, 40 ns
Pulse repetition frequency	24.4 kHz
Wavelength	850 nm

**Labelling**

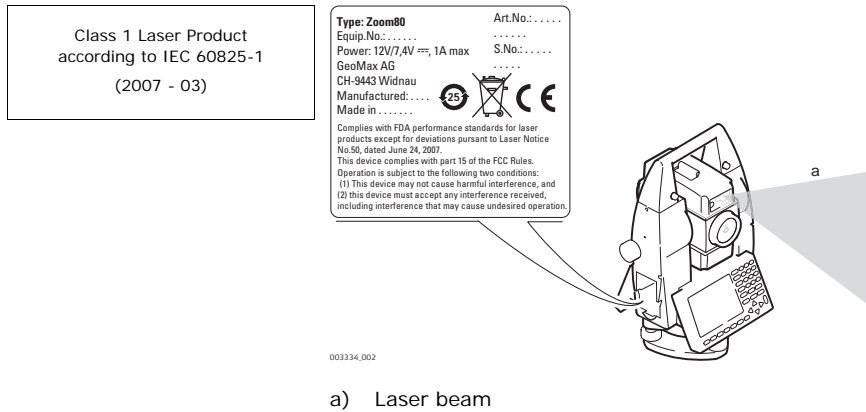

General

The integrated Navigation Light produces a visible LED beam from the front side of the telescope.



The product described in this section, is excluded from the scope of IEC 60825-1 (2007-03): "Safety of laser products".

The product described in this section, is classified as exempt group in accordance with IEC 62471 (2006-07) and does not pose any hazard provided that the product is used and maintained in accordance with this user manual.

Class 1 LED Product  
according to IEC 60825-1  
(2001 - 08)

Type: Zoom80 Art.No.: .....  
Equip.No.: .....  
Power: 12V/7AV max, 1A max S.No.: .....  
GeoMax AG  
CH-9443 Widnau  
Manufactured: .....  
Made in: .....  
Complies with FDA performance standards for laser products except for deviations pursuant to Laser Notice No.50, dated June 24, 2007.  
This device complies with part 15 of the FCC Rules. Operation is subject to the following two conditions:  
(1) This device may not cause harmful interference, and  
(2) this device must accept any interference received, including interference that may cause undesired operation.

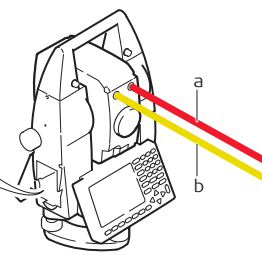

003335\_002

- a) LED beam red
- b) LED beam yellow

6.6.7

Laser Plummet

General

The laser plummet built into the product produces a visible red laser beam which emerges from the bottom of the product.

The laser product described in this section, is classified as laser class 2 in accordance with:

- IEC 60825-1 (2007-03): "Safety of laser products".
- EN 60825-1 (2007-10): "Safety of laser products".

Class 2 laser products:

These products are safe for momentary exposures but can be hazardous for deliberate staring into the beam.

Description	Value
Maximum average radiant power	1.00 mW
Pulse duration	0 - 100 %
Pulse repetition frequency	1 kHz
Wavelength	635 nm



CAUTION

From a safety perspective, class 2 laser products are not inherently safe for the eyes.

Precautions:

- 1) Avoid staring into the beam.
- 2) Avoid pointing the beam at other people.

Labelling

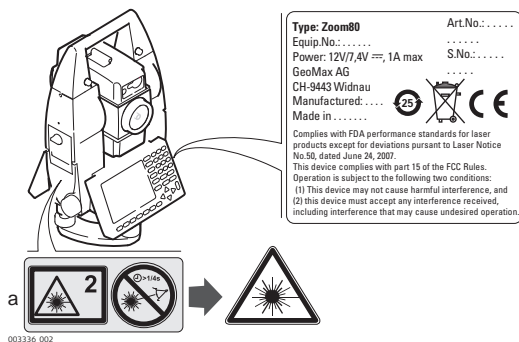

Laser Radiation  
 Do not stare into the beam  
 Class 2 Laser Product  
 according to IEC 60825-1  
 (2007 - 03)  
 Po ≤ 1.00 mW  
 λ = 620 - 690 nm

a) Will be replaced by a class 3R warning label if applicable

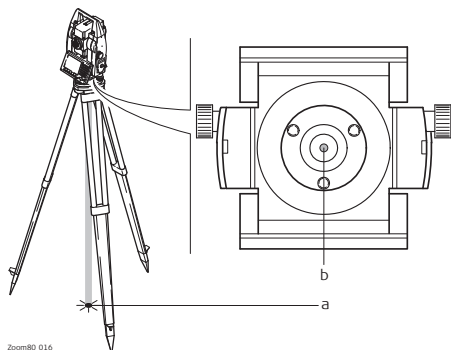

- a) Laser beam
- b) Exit for laser beam

## 6.7 Electromagnetic Compatibility EMC

**Description**

The term Electromagnetic Compatibility is taken to mean the capability of the product to function smoothly in an environment where electromagnetic radiation and electrostatic discharges are present, and without causing electromagnetic disturbances to other equipment.

**WARNING**

Electromagnetic radiation can cause disturbances in other equipment.

Although the product meets the strict regulations and standards which are in force in this respect, GeoMax cannot completely exclude the possibility that other equipment may be disturbed.

**CAUTION**

There is a risk that disturbances may be caused in other equipment if the product is used with accessories from other manufacturers, for example field computers, personal computers, two-way radios, non-standard cables or external batteries.

**Precautions:**

Use only the equipment and accessories recommended by GeoMax. When combined with the product, they meet the strict requirements stipulated by the guidelines and standards. When using computers and two-way radios, pay attention to the information about electromagnetic compatibility provided by the manufacturer.

**CAUTION**

Disturbances caused by electromagnetic radiation can result in erroneous measurements. Although the product meets the strict regulations and standards which are in force in this respect, GeoMax cannot completely exclude the possibility that the product may be disturbed by intense electromagnetic radiation, for example, near radio transmitters, two-way radios or diesel generators.

**Precautions:**

Check the plausibility of results obtained under these conditions.

**CAUTION**

If the product is operated with connecting cables attached at only one of their two ends, for example external supply cables, interface cables, the permitted level of electromagnetic radiation may be exceeded and the correct functioning of other products may be impaired.

**Precautions:**

While the product is in use, connecting cables, for example product to external battery, product to computer, must be connected at both ends.

**Radios or digital cellular phones**

Use of product with radio or digital cellular phone devices:

**WARNING**

Electromagnetic fields can cause disturbances in other equipment, in installations, in medical devices, for example pacemakers or hearing aids and in aircraft. It can also affect humans and animals.

**Precautions:**

Although the product meets the strict regulations and standards which are in force in this respect, GeoMax cannot completely exclude the possibility that other equipment can be disturbed or that humans or animals can be affected.

- Do not operate the product with radio or digital cellular phone devices in the vicinity of filling stations or chemical installations, or in other areas where an explosion hazard exists.
- Do not operate the product with radio or digital cellular phone devices near to medical equipment.
- Do not operate the product with radio or digital cellular phone devices in aircraft.

**6.8 FCC Statement, Applicable in U.S.**



The greyed paragraph below is only applicable for products without radio.

**WARNING**

This equipment has been tested and found to comply with the limits for a Class B digital device, pursuant to part 15 of the FCC rules.

These limits are designed to provide reasonable protection against harmful interference in a residential installation.

This equipment generates, uses and can radiate radio frequency energy and, if not installed and used in accordance with the instructions, may cause harmful interference to radio communications. However, there is no guarantee that interference will not occur in a particular installation.

If this equipment does cause harmful interference to radio or television reception, which can be determined by turning the equipment off and on, the user is encouraged to try to correct the interference by one or more of the following measures:

- Reorient or relocate the receiving antenna.
- Increase the separation between the equipment and the receiver.
- Connect the equipment into an outlet on a circuit different from that to which the receiver is connected.
- Consult the dealer or an experienced radio/TV technician for help.

**WARNING**

Changes or modifications not expressly approved by GeoMax for compliance could void the user's authority to operate the equipment.

**Labelling Zoom80**

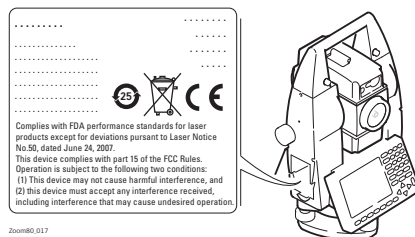

**Labelling internal battery ZBA400**

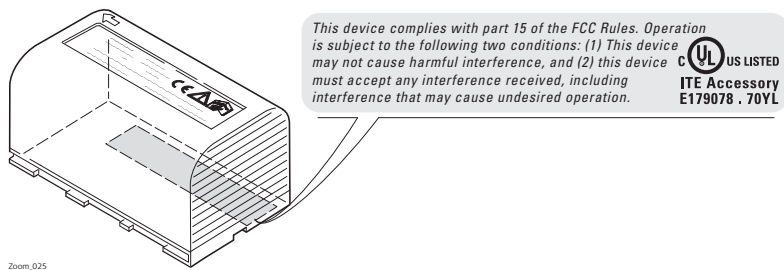

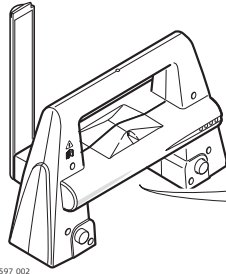

# Labelling ZRT81



004597\_002

**Type: ZRT81**  
Art.No.: 904597  
Power: 7.4V/12.5V --- /  
0.2A max.  
GeoMax AG  
G1-5433 Widnau  
Manufactured: 20XX  
Made in: .....  
Contains  
Transmitter Module:  
FCC ID: P1V0339  
IC: 5325A-6939

S No.: XXXXXX

*This device complies with part 15 of the FCC Rules. Operation is subject to the following two conditions: (1) This device may not cause harmful interference, and (2) this device must accept any interference received, including interference that may cause undesired operation.*

# 7 Technical Data

## 7.1 Instrument

### 7.1.1 General Technical Data of the Instrument

<b>Telescope</b>	Magnification:	30 x
	Clear objective diameter:	40 mm
	Focusing:	1.7 m/5.6 ft to infinity
	Field of view:	1°30'/1.66 gon. 2.7 m at 100 m

#### Compensator

Type	Setting accuracy		Setting range	
	["]	[mgon]	[']	[gon]
Zoom80 S/R 1"	0.5	0.2	4	0.07
Zoom80 S/R 2"	0.5	0.2	4	0.07
Zoom80 S/R 5"	1.5	0.5	4	0.07

<b>Level</b>	Circular level sensitivity:	6/2 mm
	Electronic level resolution:	2"

#### Control unit

Display:	1/4 VGA (320 x 240 pixels), colour, graphics capable LCD, illumination, touch screen
Keyboard:	34 keys including 12 function keys and 12 alphanumeric keys, illumination
Angle Display:	360°", 360° decimal, 400 gon, 6400 mil, V %
Distance Display:	m, ft int, ft us, ft int inch, ft us inch
Position:	In both faces, face two is optional
Touch screen:	Toughened film on glass

#### Instrument Ports

Port	Name	Description
Port 1	Port 1	<ul style="list-style-type: none"> <li>5 pin LEMO-0 for power, communication, data transfer.</li> <li>This port is located at the base of the instrument.</li> </ul>
Port 2	Handle	<ul style="list-style-type: none"> <li>Hotshoe connection for ZRT81 with instrument.</li> </ul>
Port 3	BT	<ul style="list-style-type: none"> <li>Bluetooth module for communication.</li> </ul>

#### Instrument Dimensions

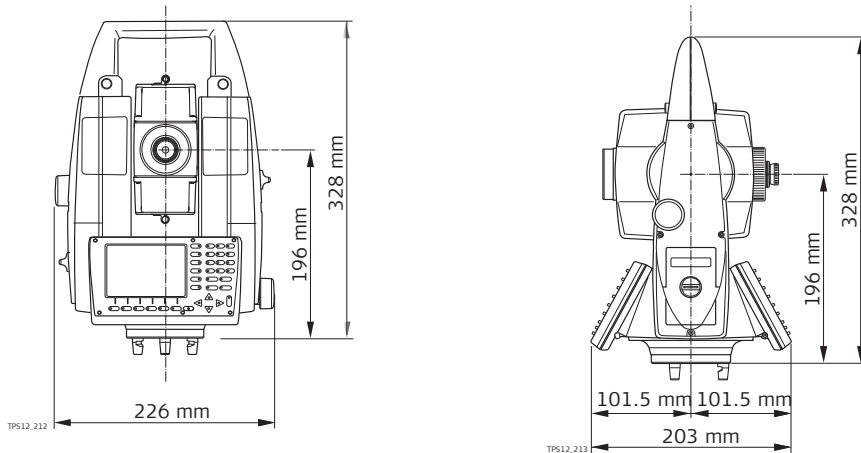

<b>Weight</b>	Instrument:	4.8 - 5.5 kg
	Tribrach:	0.7 kg
	Internal battery ZBA400:	0.2 kg



**Recording**

Data can be recorded onto a CompactFlash card.

Type	Capacity [MB]	Number of measurements per MB
CompactFlash card	256	1750

**Laser plummet**

Type: Visible red laser class 2  
 Location: In standing axis of instrument  
 Accuracy: Deviation from plumb line:  
 1.5 mm (2 sigma) at 1.5 m instrument height  
 Diameter of laser point: 2.5 mm at 1.5 m instrument height

**Drives**

Type: Endless horizontal and vertical drives

**Motorisation**

Maximum rotating speed: 45° (50 gon)/s

**Power**

External supply voltage: Nominal voltage 12.8 V DC, Range 11.5 V-13.5 V

**Internal battery**

Type: Li-Ion  
 Voltage: 7.4 V  
 Capacity: ZBA400: 4.4 Ah

**Environmental specifications****Temperature**

Type	Operating temperature [°C]	Storage temperature [°C]
Instrument	-20 to +50	-40 to +70
GeoMax CompactFlash card	-40 to +80	-40 to +80
Battery internal	-20 to +55	-40 to +70
Bluetooth	-30 to +60	-40 to +80

**Protection against water, dust and sand**

Type	Protection
Instrument	IP54 (IEC 60529)

**Humidity**

Type	Protection
Instrument	Max 95 % non condensing The effects of condensation are to be effectively counteracted by periodically drying out the instrument.

**Reflectors**

Type	Additive Constant [mm]	Aim360	Scout360
Circular prism	0.0	yes	yes
Mini prism	+17.5	yes	yes
Mini 0	0	yes	yes
360° prism	+23.1	yes	yes
360° Mini prism	+30.0	yes	not recommended
Reflective tape	+34.4	yes	no
Reflectorless	+34.4	no	no

There are no special prisms required for Aim360 or for Scout360.

**Navigation Light**

Working range: 5 m to 150 m (15 ft to 500 ft)  
 Position accuracy: 5 cm at 100 m (1.97" at 330 ft)

**Automatic corrections**

The following automatic corrections are made:

- Line of sight error
- Tilting axis error
- Earth curvature
- Circle eccentricity
- Compensator index error
- Vertical index error
- Standing axis tilt
- Refraction
- Aim360 zero point error

**7.1.2****Angle Measurement****Accuracy**

Type	std. dev. Hz, V, ISO 17123-3		Display least count	
	["]	[mgon]	["]	[mgon]
Zoom80 S/R	1	0.3	0.1	0.1
Zoom80 S/R	2	0.6	0.1	0.1
Zoom80 S/R	5	1.5	0.1	0.5

**Characteristics**

Absolute, continuous, diametric.

**7.1.3****Distance Measurement with Reflectors****Range**

Reflector	Range A		Range B		Range C	
	[m]	[ft]	[m]	[ft]	[m]	[ft]
Circular prism	1800	6000	3000	10000	3500	12000
3 prisms	2300	7500	4500	14700	5400	17700
360° prism	800	2600	1500	5000	2000	7000
360° Mini prism	450	1500	800	2600	1000	3300
Mini prism	800	2600	1200	4000	2000	7000
Reflective tape 60 mm x 60 mm	150	500	250	800	250	800

Shortest measuring distance: 1.5 m

**Atmospheric conditions**

Range A: Strong haze, visibility 5 km; or strong sunlight, severe heat shimmer  
 Range B: Light haze, visibility about 20 km; or moderate sunlight, slight heat shimmer  
 Range C: Overcast, no haze, visibility about 40 km; no heat shimmer



Measurements can be made to reflector tapes over the entire range without external ancillary optics.

**Accuracy**

Accuracy refers to measurements to standard prisms.

EDM measuring mode	std. dev. ISO 17123-4, standard prism	std. dev. ISO 17123-4, tape	Measurement time, typical [s]
Standard	1 mm + 1.5 ppm	5 mm + 2 ppm	2.4
Fast	3 mm + 1.5 ppm	5 mm + 2 ppm	0.8
Tracking	3 mm + 1.5 ppm	5 mm + 2 ppm	< 0.15

Beam interruptions, severe heat shimmer and moving objects within the beam path can result in deviations of the specified accuracy.  
 The display resolution is 0.1 mm.

**Characteristics**

Principle: Phase measurement  
 Type: Coaxial, visible red laser  
 Carrier wave: 658 nm  
 Measuring system: System analyser basis 100 MHz - 150 MHz

## 7.1.4

### Distance Measurement without Reflectors

#### Range

Type	Kodak Gray Card	Range D		Range E		Range F	
		[m]	[ft]	[m]	[ft]	[m]	[ft]
accXess10	White side, 90 % reflective	800	2630	1000	3280	>1000	>3280
accXess10	Grey side, 18 % reflective	400	1320	500	1640	>500	>1640

Range of Measurement: 1.5 m - 1200 m  
 Display unambiguous: up to 1200 m

#### Atmospheric conditions

D: Object in strong sunlight, severe heat shimmer  
 E: Object in shade, sky overcast  
 F: Underground, night and twilight

#### Accuracy

Standard measuring	std. dev. ISO 17123-4	Measure time, typical [s]	Measure time, maximum [s]
0 m - 500 m	2 mm + 2 ppm	3 - 6	12
>500 m	4 mm + 2 ppm	3 - 6	12

Object in shade, sky overcast. Beam interruptions, severe heat shimmer and moving objects within the beam path can result in deviations of the specified accuracy. The display resolution is 0.1 mm.

#### Characteristics

Type: Coaxial, visible red laser  
 Carrier wave: 658 nm  
 Measuring system: System analyser basis 100 MHz - 150 MHz

#### Laser dot size

Distance [m]	Laser dot size, approximately [mm]
at 30	7 x 10
at 50	8 x 20

## 7.1.5

### Distance Measurement - Long Range (LO mode)

#### Range

Reflector	Range A		Range B		Range C	
	[m]	[ft]	[m]	[ft]	[m]	[ft]
Circular prism	2200	7300	7500	24600	>10000	>32800

Range of measurement: 1000 m to 12000 m  
 Display unambiguous: up to 12000 m

#### Atmospheric conditions

Range A: Strong haze, visibility 5 km; or strong sunlight, severe heat shimmer  
 Range B: Light haze, visibility about 20 km; or moderate sunlight, slight heat shimmer  
 Range C: Overcast, no haze, visibility about 40 km; no heat shimmer

#### Accuracy

Standard measuring	std. dev. ISO 17123-4	Measure time, typical [s]	Measure time, maximum [s]
Long Range	5 mm + 2 ppm	2.5	12

Beam interruptions, severe heat shimmer and moving objects within the beam path can result in deviations of the specified accuracy. The display resolution is 0.1 mm.

#### Characteristics

Principle: Phase measurement  
 Type: Coaxial, visible red laser  
 Carrier wave: 658 nm  
 Measuring system: System analyser basis 100 MHz - 150 MHz

Range Aim360/Track360

Reflector	Range Aim360 mode		Range Track360 mode	
	[m]	[ft]	[m]	[ft]
Circular prism	1000	3300	800	2600
360° prism	800	2600	600	2000
360° Mini prism	350	1150	300	1000
Mini prism	500	1600	400	1300
Reflective tape 60 mm x 60 mm	55	175	not qualified	

 The maximum range can be restricted by poorer conditions, for example rain.

Shortest measuring distance: 360° prism Aim360: 1.5 m  
 Shortest measuring distance: 360° prism Track360: 5 m



Aim360 accuracy with the circular prism

Aim360 angle accuracy Hz, V 1 " (0.3 mgon)  
 (std. dev. ISO 17123-3):  
 Base Positioning accuracy (std.dev.): ± 1 mm

System accuracy with Aim360

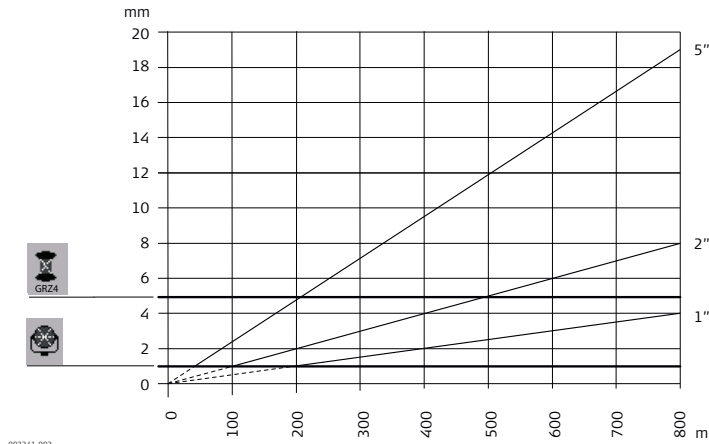
- The accuracy with which the position of a prism can be determined with Aim360 depends on several factors such as internal Aim360 accuracy, instrument angle accuracy, prism type, selected EDM measuring program and the external measuring conditions. The Aim360 has a basic standard deviation level of ± 1 mm. Above a certain distance, the instrument angle accuracy predominates and takes over the standard deviation of the Aim360.
- The following graph shows the Aim360 standard deviation based on different prism types, distances and instrument accuracies.



 Leica GRZ4 prism (360°)  
 Circular prisms and circular Mini prisms  
 mm Aim360 accuracy [mm]  
 m Distance measurement [m]  
 " Instrument angle accuracy ["]

Maximum speed in Track360 mode

Maximum tangential speed: 5 m/s at 20 m; 25 m/s at 100 m  
 Maximum radial speed with <EDM Mode: Tracking> 5 m/s

Searching

Typical search time in field of view: 1.5 s  
 Field of view: 1° 25'/1.55 gon  
 Definable search windows: Yes

Characteristics

Principle: Digital image processing  
 Type: Infrared laser

## 7.1.7

## Scout360

### Range

Reflector	Range Track360	
	[m]	[ft]
Circular prism	300	1000
360° prism	300*	1000*
Mini prism	100	330

Measurements at the vertical limits of the fan or under unfavourable atmospheric conditions may reduce the maximum range. (\*optimally aligned to the instrument)

Shortest measuring distance: 1.5 m

### Searching

Typical search time: < 10 s  
 Default search area: Hz: 400 gon, V: 40 gon  
 Definable search windows: Yes

### Characteristics

Principle: Digital signal processing  
 Type: Infrared laser

## 7.1.8

### Scale Correction

#### Use of scale correction

By entering a scale correction, reductions proportional to distance can be taken into account.

- Atmospheric correction.
- Reduction to mean sea level.
- Projection distortion.

#### Atmospheric correction $\Delta D1$

The slope distance displayed is correct if the scale correction in ppm, mm/km, which has been entered corresponds to the atmospheric conditions prevailing at the time of the measurement.

The atmospheric correction includes:

- Adjustments for air pressure
- Air temperature
- Relative humidity

For highest precision distance measurements, the atmospheric correction should be determined with an accuracy of 1 ppm. The following parameters must be redetermined:

- Air temperature to 1 °C
- Air pressure to 3 mbar
- Relative humidity to 20 %

#### Air humidity

The air humidity influences the distance measurement if the climate is extremely hot and damp. For high precision measurements, the relative humidity must be measured and entered along with the air pressure and the temperature.

#### Air humidity correction

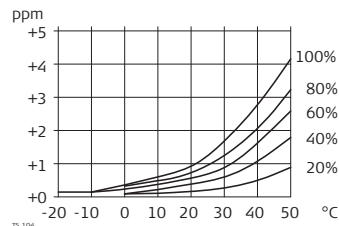

ppm Air humidity correction [mm/km]  
 % Relative humidity [%]  
 C° Air temperature [°C]

#### Index n

Type	Index n	carrier wave [nm]
combined EDM	1.0002863	658

The index n is calculated from the formula of Barrel and Sears, and is valid for:

Air pressure p: 1013.25 mbar  
 Air temperature t: 12 °C  
 Relative air humidity h: 60 %

## Formulas

Formula for visible red laser

$$\Delta D_1 = 286.34 \cdot \left[ \frac{0.29525 \cdot p}{(1 + \alpha \cdot t)} - \frac{4.126 \cdot 10^{-4} \cdot h}{(1 + \alpha \cdot t)} \cdot 10^x \right]$$

TS.105

$\Delta D_1$  Atmospheric correction [ppm]

p Air pressure [mbar]

t Air temperature [°C]

h Relative humidity [%]

$$\alpha = \frac{1}{273.15}$$

$$x = (7.5 \cdot t / (237.3 + t)) + 0.7857$$

If the basic value of 60 % relative humidity as used by the EDM is retained, the maximum possible error in the calculated atmospheric correction is 2 ppm, 2 mm/km.

## Reduction to mean sea level $\Delta D_2$

The values for  $\Delta D_2$  are always negative and are derived from the following formula:

$$\Delta D_2 = - \frac{H}{R} \cdot 10^6$$

TS.106

$\Delta D_2$  Reduction to mean sea level [ppm]

H Height of EDM above sea level [m]

$$R = 6.378 \cdot 10^6 \text{ m}$$

## Projection distortion $\Delta D_3$

The magnitude of the projection distortion is in accordance with the projection system used in a particular country, for which official tables are generally available. The following formula is valid for cylindrical projections such as that of Gauss-Krüger:

$$\Delta D_3 = \frac{X^2}{2R^2} \cdot 10^6$$

TS.107

$\Delta D_3$  Projection distortion [ppm]

X Easting, distance from projection zero line with the scale factor 1 [km]

$$R = 6.378 \cdot 10^6 \text{ m}$$

In countries where the scale factor is not unity, this formula cannot be directly applied.

## Atmospheric corrections °C

Atmospheric corrections in ppm with temperature [°C], air pressure [mb] and height [m] at 60 % relative humidity.

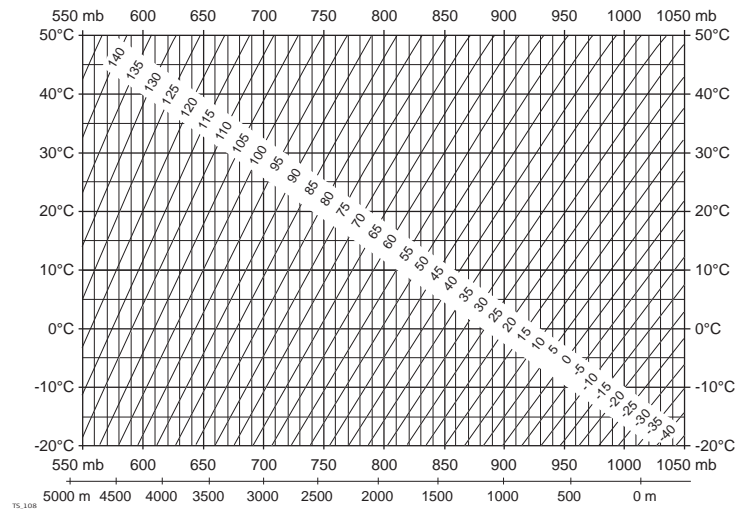

## Atmospheric correction °F

Atmospheric corrections in ppm with temperature [°F], air pressure [inch Hg] and height [ft] at 60 % relative humidity.

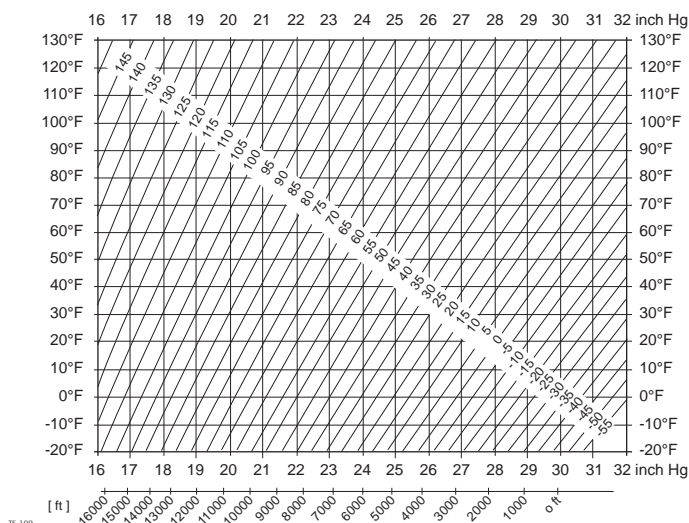

## 7.1.9

### Reduction Formulas

#### Measurements

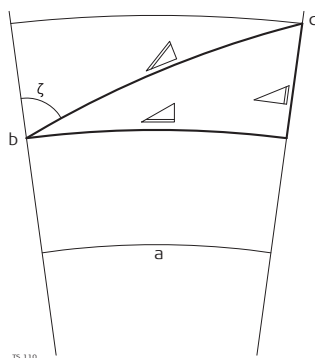

- a) Mean Sea Level
- b) Instrument
- c) Reflector
- Slope distance
- Horizontal distance
- Height difference

#### Reflector types

The reduction formulas are valid for measurements to all reflector types:

- measurements to prisms, to reflector tape and reflectorless measurements.

#### Formulas

The instrument calculates the slope distance, horizontal distance, height difference in accordance with the following formulas:

$$\triangle = D_0 \cdot (1 + \text{ppm} \cdot 10^{-6}) + \text{mm}$$

- Displayed slope distance [m]
- $D_0$  Uncorrected distance [m]
- ppm Atmospheric scale correction [mm/km]
- mm Additive constant of the reflector [mm]

$$\triangle = Y - A \cdot X \cdot Y$$

- Horizontal distance [m]
- Height difference [m]

$$\triangle = X + B \cdot Y^2$$

- $Y$  \*  $|\sin \zeta|$
- $X$  \*  $\cos \zeta$
- $\zeta$  Vertical circle reading
- $A$   $(1 - k/2)/R = 1.47 \cdot 10^{-7} \text{ [m}^{-1}\text{]}$
- $B$   $(1 - k)/2R = 6.83 \cdot 10^{-8} \text{ [m}^{-1}\text{]}$
- $k$  0.13 (mean refraction coefficient)
- $R$   $6.378 \cdot 10^6 \text{ m}$  (radius of the earth)

Earth curvature (1/R) and mean refraction coefficient (k) (if enabled on the Refraction page in Main Menu: Config...Instrument Settings...TPS Corrections) are automatically taken into account when calculating the horizontal distance and height difference. The calculated horizontal distance relates to the station height and not to the reflector height.

## Distance measuring program Averaging

In the distance measuring program Averaging, the following values are displayed:

- D Slope distance as arithmetic mean of all measurements
- s Standard deviation of a single measurement
- n Number of measurements

These values are calculated as follows:

$$\bar{D} = \frac{1}{n} \cdot \sum_{i=1}^n D_i$$

TS.114

$$s = \sqrt{\frac{\sum_{i=1}^n (D_i - \bar{D})^2}{n - 1}} = \sqrt{\frac{\sum_{i=1}^n D_i^2 - \frac{1}{n} (\sum_{i=1}^n D_i)^2}{n - 1}}$$

TS.115

- $\bar{D}$  Slope distance as arithmetic mean of all measurements
- $\sum$  Sum
- $D_i$  Single slope distance measurement
- n Number of measurements
- s Standard deviation of a single slope distance measurement
- $\sum$  Sum
- $\bar{D}$  Slope distance as arithmetic mean of all measurements
- $D_i$  Single slope distance measurement
- n Number of distance measurements

The standard deviation  $S_{\bar{D}}$  of the arithmetic mean of the distance can be calculated as follows:

$$S_{\bar{D}} = \frac{s}{\sqrt{n}}$$

TS.116

- $S_{\bar{D}}$  Standard deviation of the arithmetic mean of the distance
- s Standard deviation of a single measurement
- n Number of measurements

## 7.2

## Conformity to National Regulations

### 7.2.1

### Instrument

#### Conformity to national regulations

- FCC Part 15 (applicable in US).
- Hereby, GeoMax AG, declares that the instrument Zoom80 is in compliance with the essential requirements and other relevant provisions of Directive 1999/5/EC. The declaration of conformity is available from GeoMax AG.



Class 1 equipment according European Directive 1999/5/EC (R&TTE) can be placed on the market and be put into service without restrictions in any EEA Member state.

- The conformity for countries with other national regulations not covered by the FCC part 15 or European directive 1999/5/EC has to be approved prior to use and operation.

#### Frequency band

2402 - 2480 MHz

#### Output power

<b>Bluetooth:</b>
4 mW max.

#### Antenna

Type: Internal Microstrip antenna  
Gain: 1.5 dBi



**Conformity to national regulations**

- FCC Part 15 (applicable in US)
- Hereby, GeoMax AG, declares that the ZRT81 is in compliance with the essential requirements and other relevant provisions of Directive 1999/5/EC. The declaration of conformity is available from GeoMax AG.



Class 1 equipment according European Directive 1999/5/EC (R&TTE) can be placed on the market and be put into service without restrictions in any EEA Member state

- The conformity for countries with other national regulations not covered by the FCC part 15 or European directive 1999/5/EC has to be approved prior to use and operation.

**Frequency band**

Limited to 2402 - 2480 MHz

**Output power**

< 100 mW (e. i. r. p.)

**Antenna**

Type:  $\lambda/2$  dipole antenna  
 Gain: 2 dBi  
 Connector: Special customized SMB

**Software Licence Agreement**

This product contains software that is preinstalled on the product, or that is supplied to you on a data carrier medium, or that can be downloaded by you online according to prior authorisation from GeoMax. Such software is protected by copyright and other laws and its use is defined and regulated by the GeoMax Software Licence Agreement, which covers aspects such as, but not limited to, Scope of the Licence, Warranty, Intellectual Property Rights, Limitation of Liability, Exclusion of other Assurances, Governing Law and Place of Jurisdiction. Please make sure, that at any time you fully comply with the terms and conditions of the GeoMax Software Licence Agreement.

Such agreement is provided together with all products and can also be referred to and downloaded at the GeoMax home page at <http://www.geomax-positioning.com> or collected from your GeoMax distributor.

You must not install or use the software unless you have read and accepted the terms and conditions of the GeoMax Software Licence Agreement. Installation or use of the software or any part thereof, is deemed to be an acceptance of all the terms and conditions of such Licence Agreement. If you do not agree to all or some of the terms of such Licence Agreement, you must not download, install or use the software and you must return the unused software together with its accompanying documentation and the purchase receipt to the distributor from whom you purchased the product within ten (10) days of purchase to obtain a full refund of the purchase price.

---

# Index

<b>A</b>	
A10	5
Accuracy	
Angle measurement	42
IR mode	42
LO mode	43
RL mode	43
Adjustment	
Combined (l, t, i, c and Aim360)	23
Electronic	22
Inspecting laser plummet	27
Inspecting the laser plummet	27
Mechanical	22
Of circular level on instrument	26
Of circular level on prism pole	26
Of circular level on tribrach	26
Preparation	23
Tilting axis (a)	25
Adjustment Errors	
View current	22
Aim360	
Accuracy with the circular prism	44
Description	34, 44
Positioning of crosshairs	23
System accuracy	44
Angle measurement	42
Antenna	48
ZRT81	49
Autodetect behaviour	16
ZRT81	16
Automatic Corrections	42
<b>B</b>	
Batteries	
Operation, Discharging	17
Battery	
Icon	13
Labelling	38
Technical data ZBA400	41
Bluetooth port	
Graphical overview with ZRT81	8
Bluetooth, icon	13
<b>C</b>	
CE	9
Check & Adjust	22
CompactFlash Card	7
Format card	19
Icon	13
Compensator	40
Container Contents	
For instrument	7
Control unit	40
Conversion of data	7
Corrections	
Automatic	42
Scale	45
<b>D</b>	
Data conversion	7
Data Conversion	7
Data Storage	7
Data transfer to GGO	7
Definition of Use	30
Description of the system	5
Dimensions	
Of instrument	40
Distance Measurement	
Any surface mode	43
LO mode	43
Prism mode	42
Documentation	2
Drive	
PC card, on office computer	7
Drives	41
<b>E</b>	
Edit	
Value in input field	10
Electronic Adjustment	22
Electronic Distance Measurement EDM	
accXess	5
Description	5
Screen icons	13, 13
ENTER	9
Environmental Specifications	41
ESC	9
<b>F</b>	
FCC Statement	38
Frequency Band	48
ZRT81	49
<b>G</b>	
GGO, description	5
Guidelines for Correct Results	21
<b>I</b>	
Icons	13
Instrument	
Dimensions	40
Ports	40
Setup	14
Technical data	48
Technical Data	40
Turn on and turn off	12
Weight	40
Instrument Models	6
Instrument Setup	
For remote control	15
Internal memory, icon	13
<b>K</b>	
Keyboard	9
Locking and unlocking	12
Operating principles	10
Keys	9
Keys, Alphanumeric	9
Keys, Arrow	9
Keys, Combinations	9
Keys, Function	9
Keys, Hot	9
<b>L</b>	
Labelling	38
Laser	
Classification	32

Laser Classification		
Aim360	34, 44	
Integrated Distancer, Invisible Laser	33	
Integrated Distancer, Visible Laser	33	
Scout360	35, 45	
Laser plummet		
Inspect	27	
Safety directions	36	
Technical data	41	
Level	9, 40	
Lights	9	
Li-Ion battery		
Storage	28	
Lock, keyboard	12	
<b>M</b>		
Mechanical Adjustment	22	
Menu, selecting from a	10	
<b>N</b>		
Navigation Light		
Safety directions	36	
Navigation Light NavLight		
Technical data	41	
<b>O</b>		
ON	9	
Output Power		
Instrument	48	
ZRT81	49	
<b>P</b>		
Page		
Selecting from a	11	
Pages down	9	
Pages up	9	
PC card drive on office computer	7	
Ports	40	
Power supply	6	
Precise Measurements	22	
PROG	9	
<b>Q</b>		
Quick coding, icon	13	
Quick settings	9	
<b>R</b>		
Recording	41	
Reduction Formulas	47	
Reflectors	41	
Responsibilities	31	
<b>S</b>		
Safety Directions	30	
Screen	10	
Scroll bar, description	10	
Setup		
For remote control	15	
Instrument	14	
SHIFT	9, 13	
Software		
Application programs	6	
Language software	6	
Software type	6	
Software upload	6	
System software	6	
Software Licence Agreement	50	
Survey Application	20	
<b>T</b>		
Telescope	40	
Temperature		
Battery Internal		
Operating	41	
Storage	41	
Bluetooth		
Operating	41	
Storage	41	
CompactFlash Card		
Operating	41	
Storage	41	
Instrument		
Operating	41	
Storage	41	
Temperature range		
Product, drying	28	
Touch Screen, operating principles	10	
Transfer raw data to GGO	7	
<b>U</b>		
Unlock, keyboard	12	
USER	9	
User Interface	9	
User Manual		
Validity of	2	
<b>V</b>		
Value		
Edit in input field	10	
View Current Adjustment Errors	22	
<b>W</b>		
Weight		
Of instrument	40	
<b>Z</b>		
ZRT81		
Description	5	
Setup for remote control	15	
Technical data	49	



# GeoMax Zoom80 Series



**794008-2.2.0en**

**Original text**

© 2013 GeoMax AG, Widnau, Switzerland

**GeoMax AG**  
[www.geomax-positioning.com](http://www.geomax-positioning.com)